



Supporting  
Canada  
Counts.

# 2021



Established 1954

## VANDEN BUSSCHE.com

IRRIGATION

**Ottawa**  
Sales Office  
Tel: (613) 854-2888

**Concord**  
77 Maplecrete Rd.  
Concord, ON L4K 1A5  
Tel: 1-866-703-5464

**Burlington**  
2462 Industrial St., Units 3&4  
Burlington, ON L7P 1A5  
Tel: (905) 634-7246

**Delhi**  
2515 Pinegrove Rd.  
Delhi, ON N4B 2X1  
Tel: 1-800-387-RAIN (7246)

**RAIN BIRD**

**Hunter**

**FXLuminaire**

**LASCO**  
Fittings, Inc.

**OIL CREEK**  
PLASTICS  
QUALITY. SERVICE. INTEGRITY.

**ALLIANCE**  
OUTDOOR LIGHTING



**IPEX**



# Vanden Bussche Irrigation Contacts

## DELHI - HEAD OFFICE

AGRICULTURE, LANDSCAPE & GOLF

Toll Free: 1-800-387-7246

Tel: (519) 582-2380

**Marc Vanden Bussche**

President

[mvanden@vandenbussche.com](mailto:mvanden@vandenbussche.com)

**Albert Darnbrough**

Inside Sales

[adarnbrough@vandenbussche.com](mailto:adarnbrough@vandenbussche.com)

**Gerad Vanden Bussche**

Landscape Territory Manager  
(Southwestern Ontario)

[gfvanden@vandenbussche.com](mailto:gfvanden@vandenbussche.com)

## LANDSCAPE & GOLF DIVISION

Toll Free: 1-800-263-4112

Tel: (905) 875-4545

**Kim Borst**

Reception/Credit Associate

[kborst@vandenbussche.com](mailto:kborst@vandenbussche.com)

## CONCORD

### LANDSCAPE & GOLF

Toll Free: 1-866-703-5464

Tel: (905) 660-5464

**Bob Beauchemin**

Branch Manager

[bbeauchemin@vandenbussche.com](mailto:bbeauchemin@vandenbussche.com)

**Vic Moolchan**

Assistant Branch Manager

[vmoolchan@vandenbussche.com](mailto:vmoolchan@vandenbussche.com)

**Rob Cooke**

Sales Manager, Golf & Landscape

[rcooke@vandenbussche.com](mailto:rcooke@vandenbussche.com)

**Colin MacLellan**

Project & Sales Coordinator

[cmaclellan@vandenbussche.com](mailto:cmaclellan@vandenbussche.com)

**Phil Brown**

Golf Territory Manager

(Toronto & Northern Ontario)

[pbrown@vandenbussche.com](mailto:pbrown@vandenbussche.com)

**Michael Di Nunzio**

Landscape Territory Manager

(Northern Ontario)

[mdinunzio@vandenbussche.com](mailto:mdinunzio@vandenbussche.com)

**Dan Columbus**

Service Technician - Landscape  
& Golf

[dcolumbus@vandenbussche.com](mailto:dcolumbus@vandenbussche.com)

**Devon Lalchan**

Inside Sales

[dlalchan@vandenbussche.com](mailto:dlalchan@vandenbussche.com)

## BURLINGTON

### LANDSCAPE & GOLF

Tel: (905) 634-7246

**Liam Bryck**

Branch Manager

[lbryck@vandenbussche.com](mailto:lbryck@vandenbussche.com)

**Marc Craddock**

Golf Territory Manager  
(Southwestern Ontario)

[mcraddock@vandenbussche.com](mailto:mcraddock@vandenbussche.com)

## OTTAWA & EASTERN ONTARIO

Tel: (613) 854-2888

**Al Saunders**

Landscape & Golf Territory  
Manager

(Eastern Ontario & Western  
Quebec)

[asaunders@vandenbussche.com](mailto:asaunders@vandenbussche.com)

**CONNECT WITH US**  
[www.vandenbussche.com](http://www.vandenbussche.com) | [info@vandenbussche.com](mailto:info@vandenbussche.com)







# STRONG

roots in agriculture



# STRONG

results in landscaping

## VANDEN BUSSCHE REALIGNMENT STRATEGY: INVESTING IN PEOPLE & TECHNOLOGY

In August of 2020, we implemented a realignment strategy with the main focus rooted in efficiency and operational excellence, and an end goal of increased customer satisfaction. Our realignment is allowing us to enhance our ability to distribute world class Irrigation and Landscape products and solutions, and to improve our ability to offer more value to our employees, customers and vendors.

Although there are many factors that contribute to our over 60 years of successes, the cornerstone for us has been the focus and dedication to our customer first approach. One thing that we as a company have learned in our tenure, is the only constant is change. Changes and innovations in business today happen at an increasingly rapid pace compared to previous decades. The ability to innovate and adapt to the demands of today's world is paramount to remaining strong and progressing for the future. In accordance, we have closed our doors to our locations in Scarborough (closed August 2020) and Milton (closed October 2020) in efforts to prioritize resources away from "bricks and mortar" and invest in the development and enhancement of our Concord and Burlington locations. We are excited to be moving forward with our strategic initiatives as we continually work to be the best version of Vanden Bussche Irrigation.

### MEMBER ASSOCIATIONS



**Landscape Ontario**  
HORTICULTURAL TRADES ASSOCIATION



ONTARIO PARKS ASSOCIATION  
Protecting Tomorrow Today®



Ontario Association of  
Landscape Architects



THE ONTARIO GOLF  
SUPERINTENDENTS  
ASSOCIATION



THE CANADIAN GOLF  
SUPERINTENDENTS  
ASSOCIATION



### Prices

Prices are subject to change without notice. Prices invoiced will be the price in effect at the time of shipping or pickup.

Prices in the catalogue are list prices and are subject to trade discounts which may vary according to the product quantity.

Where "NET" is shown next to a price, there is no trade discount available.

HST will be charged separately on the invoice.

### Credit Policy

For those with established records of prompt payment, we are glad to grant reasonable credit terms. New accounts are cash C.O.D. until a record is established with us. We require trade and bank references for establishment of our credit. The minimum charge on account is \$25.

### Delivery - Freight Terms

Delivery terms are available upon request. All deliveries are subject to charge.

### Delivery Schedule

Vanden Bussche Irrigation will deliver to different regions on a weekly schedule. Please call for details.

Claims for shortages/errors made on packing slips or delivery must be made within seven(7) days of receipt of order.

\*\*Vanden Bussche will be responsible for delivering orders to customer's place of business or job site safely and undamaged. Although our drivers will be happy to aide in the off-loading of these orders, it remains the responsibility of the customer for any damage or losses incurred during off-loading. It is the customers responsibility to supply any equipment needed in the off-loading of orders.

### Special Orders

All special orders must be made in writing (fax or email). All special non-stock orders must be prepaid and may not be cancelled or returned. Shipping surcharge may be applicable.

### Warranty

All products are subject to manufacturer's warranties. Product exchanges will be made. No credit will be issued on a warranty return.

### Returned Merchandise

Although we are happy to assist with all your irrigation needs the best we can, Vanden Bussche Irrigation & Equipment Limited does adhere to a strict merchandise return policy.

Our policy is NOT to accept returned goods. All sales are final when a customer takes receipt of product. However, we do understand that some exceptions may apply and items for return will be assessed on a case by case basis.

The following parameters may involve acceptance to the NO RETURNS rule:

1. All returns for product must be completed within 3 months of original purchase. Items that exceed the 3 months, may NOT be returned for credit or otherwise.
2. All customers must have proof of purchase at the time of the return process. This can be either a Vanden Bussche Irrigation & Equipment Ltd. Packing Slip or Invoice. Customers without proof of purchase will not be eligible for credit or otherwise.
3. NO returns will be completed for Non-Stock items of any kind, unless approved by the vendor or GM.
4. All items being returned must be in "re-saleable" condition. Vanden Bussche Irrigation & Equipment Ltd., will not accept any damaged, dirty or unkempt product regardless of the number of days from purchase.
5. All returns will be subject to a 20% re-stocking fee or at minimum, a \$20 Administration Fee, unless picking error of product was made by a VBI staff member.
6. Shipments are prepaid to the originating VBI location.

### Hours of Operation

#### April - Mid October

Monday - Thursday: 7:00am-5:00pm  
Friday: 7:00am-4:30pm

Saturday: Contact your branch for further details.

Sunday: Closed

#### Mid October - April

Weekdays: 8:00am-4:00pm

Weekends: Closed

### Holiday Long Weekends

Contact your branch for details regarding long weekend closures.

### Off Season Closures

Some of our branches may be closed during the winter. Please see your branch for more information

Vanden Bussche Irrigation is closed for a full week at the end of November each year, due to inventory count. Please see your branch for specific closure dates.





Established 1954

# VANDEN BUSSCHE IRRIGATION



## Online Training Portal



- Irrigation Association certified
- Water Smart Irrigation Professional certified
- On-board new or seasonal employees
- Learn potential new services like Landscape Lighting or Drainage
- Effective use of time on bad weather days

See pg. 59 for full details.

## Mobile App

WHENEVER. WHEREVER.  
THE ULTIMATE CONVENIENCE.

Order parts • Track order status • Check history



Download on the  
App Store



GET IT ON  
Google Play





## GOLF PRODUCTS

Golf Services.....	8
Rain Bird Control Systems.....	9-11
Rain Bird Rotors & Tools.....	12-14
WX Line.....	15
Brass Sprinklers, Turf Valves, Accessories.....	17
Saddles & Swing Joints & Tap Tees.....	18-19
HARCO Fittings.....	20-22
Isolation Valves.....	23
PVC Pipe.....	25
Schedule 40 Fittings.....	26-28
Schedule 80 Fittings & Repair Couplings.....	29-31

## RAIN BIRD IRRIGATION

Spray Heads.....	33-35
Rotors.....	36-38
Controllers.....	39-44
Valves.....	45
Flow Meters.....	46

## HUNTER IRRIGATION

Spray Heads.....	49-50
Valves.....	51
Rotors.....	52-54
Controllers.....	55-58
Swing Pipe, Saddles & Fittings.....	61-63
Valve Boxes.....	64
Poly Pipe.....	66
Clamps.....	67
Insert Fittings & Nipples.....	69-71
Electrical Wire, Connectors & Tools.....	72-73
Backflow Prevention.....	74
Copper & TecTite Fittings.....	75-76

## PUMPS

Berkeley Pumps.....	78
Franklin Pumps.....	79
Franklin Inline Pumps & Controls.....	80
Submersible Pumps & Controls.....	81
Galvanized Fittings.....	82
Pump Accessories.....	83

## DRIP IRRIGATION

Rain Bird Drip Irrigation.....	84
Hunter & Netafim Drip.....	85
Rain Bird Point Source Irrigation.....	86
Drip Parts & Accessories.....	87
Filters.....	88-89
Kifco Hose Reels.....	90

## LANDSCAPE LIGHTING

FX Luminaire Fixtures.....	92-94
Alliance Fixtures.....	96-99
Cast Fixtures.....	101
WAC Fixtures.....	103
Focus Fixtures.....	104
Moon Visions Fixtures.....	105
Brilliance LED Lamps.....	107-108
Transformers, Timers & Accessories.....	109
Installation Material & Accessories.....	110

## POND CARE

Arbourdale Products.....	113
Aerators & Fountains.....	114
Aquascape.....	115-116

## DRAINAGE

NDS Drainage.....	117-119
ADS Drainage.....	120
Hand Tools & Accessories.....	121-122
Irrigation Tools & Accessories.....	124-125
Hot Boxes.....	126
Technical Information.....	127-129

## Product In-Stock Guarantee (P.I.G. Program)



Find a  beside a product in our catalogue; indicates an item on the P.I.G. Program.

More info on page 100.



# THE ONLY ONE OF ITS KIND.

Rain Bird® IC System™ — true,  
two-way integrated control.



## Expanded Control with IC CONNECT™

Collect more data and remotely  
control field equipment.

## Eliminate Satellites and Decoders

A simplified, single component  
design is all you need.

See why golf courses in over 50 countries  
around the world trust the proven performance  
of the IC System at [rainbird.com/ICAdvantage](http://rainbird.com/ICAdvantage).



# RAIN BIRD®



## Golf & Commercial Services

### Dan Columbus

Service Technician - Landscape & Golf  
Tel: (905) 660-5464  
Cell: (416) 805-7632  
dcolumbus@vandenbussche.com

### Colin MacLellan

Project & Sales Coordinator  
Tel: (905) 660-5464  
Cell: (905) 251-2386  
cmacellan@vandenbussche.com

### Al Saunders

Golf Field Service &  
Territory Manager (Eastern Ontario)  
Tel: (613) 854-2888  
asaunders@vandenbussche.com

Vanden Bussche Irrigation and Rain Bird are specialized irrigation-only companies focused on water management, efficiency, and conservation for the golf irrigation market. Vanden Bussche Irrigation staff are highly trained with the expertise needed in order to satisfy your irrigation needs.

#### On-Site Troubleshooting

Vanden Bussche Irrigation provides professional on-site troubleshooting for all golf irrigation systems, while specializing in Rain Bird control systems for:

- Central Control
- Decoder
- 2-Wire & Link
- Integrated Control Systems

#### Other professional services we provide:

- Wire Tracing
- Ground Fault Finding
- Communication Issues

#### Preventative Maintenance

- Grounding Tests
- Surge Protection
- Satellite Clean Out
- Weather Stations

#### GPS & Mapping Services

- Updating or Digitizing Current Maps
- As-Built Maps
- Irrigation Design
- Asset Location
- Central Control Integration
- Radio Survey

#### Pump Services

- Pump station efficiency assessments
- Pump station servicing
- Pump station design for electric or diesel applications
- Pump rentals for diesel or PTO pumps

#### System Training

Proper training is an essential element in successfully managing your irrigation system. If you require training to better understand your system, just let us know. We can provide one-on-one training or save you a spot at our next training event.

The benefits of one-on-one training are obvious. We can provide professional assistance to ensure you are trained to troubleshoot your irrigation system. Understanding the benefits and challenges you encounter specifically with your system can often be the most valuable training available.



**RAIN BIRD**

**Global  
Service  
Plans**

Contact your Territory Manager for further details

**Protect your investment  
Maximize system life  
Control your budget**







## MI Series Mobile Controllers

Remote access to your central control is now as convenient as the internet, with mobile control. This software runs on your central control computer to provide remote irrigation control via a web-enabled cell phone or tablet.

The Rain Bird MI Series Mobile Controller is designed to work on a standard cell phone with Internet connectivity and offers the user far more remote options than other devices currently available in the marketplace.

Once connected, up to 9 remote users are able to simultaneously perform remote operations ranging from activating sprinklers and programs, observing status updates, or directly editing central control sprinkler and program data.



## Rain Watch

Patented Rain Bird® RainWatch technology maximizes water efficiency while minimizing system wear and tear through intelligent, real-time decision-making based on accurate rainfall measurement.



## Weather Stations

Eliminate unnecessary watering and reduce costs with Rain Bird's WS-PRO weather stations. \*WS-PRO and WS-PRO LT available.



## The Freedom System

The FREEDOM™ System puts the power of central control in the palm of your hand.

Features:

- Simple commands for ease of use.
- Reliable two-way hand-held radio allows computer to log and flow manage all manual watering.



## Pump Stations

- Electronically controlled VFD pump stations
- Constant speed pump stations

Additional Rain Bird® Pump Station variations include:

- Flows up to 10000 gpm capacity.
- Pump components vary depending on application and budget.
- Real-Time Communication: The pump station communicates in real time with the central control.







# The TRUE Benefits of a Rain Bird System



## IC System Connect to the Future

Achieving optimal playing conditions isn't about working harder, it's about working smarter. Add Rain Bird's intelligent IC System with IC CONNECT™ and you're on your way. Communicate directly with every rotor on your course and gain one-of-a-kind course management with IC CONNECT. With an intuitive interface operated from a computer, tablet or mobile device, the IC System puts control in your hands, anywhere.

By updating your existing PAR+ES Controllers with the IFX Satellite Board\*, you now have the ability to add IC Rotors and Valves by simply tapping into the existing satellite MAXI™ Cable.

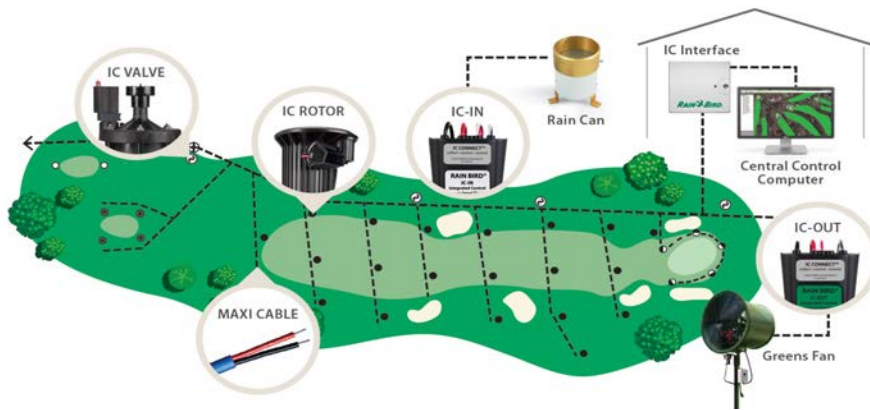

RAIN BIRD IC PARTS	DESCRIPTION	PRICE
AXICSD	IC Surge Device	\$ 275.71
AXICM	IC Module	\$ 438.90
AXICMVLKIT	ICM Valve Adapter Kit	\$ 537.66
AXM61010	4" Maxicom Rain Can	\$ 1,352.00
AXHS4000	IC IN	\$ 2,634.43
AXHS5000	IC OUT	\$ 2,360.02

### Advanced Features in a Simple, Expandable Design

With features that enable you to streamline installation and benefits that reach beyond the golf course, the Rain Bird IC System with IC CONNECT™ delivers one-of-a-kind property management.

- No satellites or decoders
- Up to 90% less wire
- Test over 1,000 stations in 45 seconds
- Add components anywhere there is MAXI™ Cable

## ICI + SYSTEM

### The Industry's Only Integrated Course Control

With Rain Bird's Integrated Control Interface Plus (ICI+) and ICI+LINK, you can bring the intelligent IC System™, Two-Wire Satellites and LINK™ (wireless) Satellites all onto the same interface.

Rain Bird ICI+ and ICI+LINK open up new and less disruptive ways to renovate or expand your course with the IC System. Add IC Rotors and Valves, as well as IC CONNECT™, by updating your satellite interface boards and tapping into your existing MAXI™ Cable.



**Complete Control in One Interface:** Manage Rain Bird Two-Wire Satellites, LINK Satellites, IC System or any combination of all three from one interface.

**An Easier Way to Upgrade:** Extend the life of your current system and get the latest in irrigation technology without a complete overhaul.

**Unmatched Wireless Capabilities:** Get greater design flexibility without communication wires and license requirements with ICI + LINK.

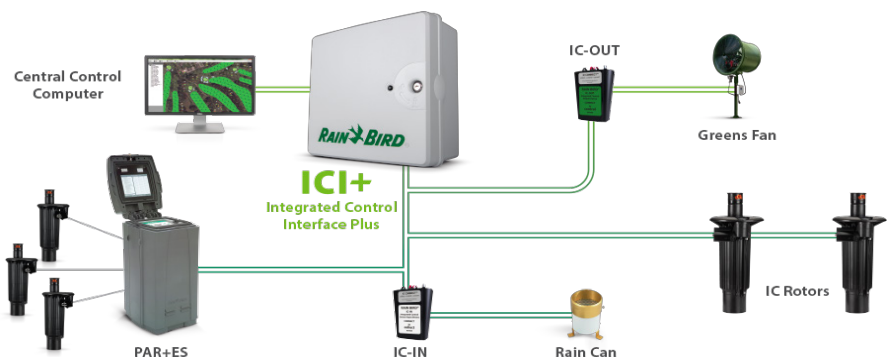

St. George's Golf and Country Club | Etobicoke, Ontario

"With the Rain Bird ICI+, I was able to get the latest technology without going through a major renovation, saving me considerable time and money."

- Ian McQueen, Golf Course and Property Manager





## Satellite Controllers

### PAR + ES

Boasting advanced technology, our updated PAR+ES Satellite Controllers feature IFX Satellite Boards that take communicating with Rain Bird's Integrated Control Interface Plus (ICI+) and IC System™ to the next level.



The easy-to-use program, central control-ready Rain Bird® PAR+ES Controller features 72-station capability, unlimited programs with central control, premium surge protection, extensive diagnostics and a best-in-class pedestal enclosure.

AXPARESRETRO kit includes:
Retro Kit PAR+ES 16 Station
1 PIB
2 OSM
PAR+ES Face Plate
Transformer
Mounting Bracket
Price: \$ 5,762.78

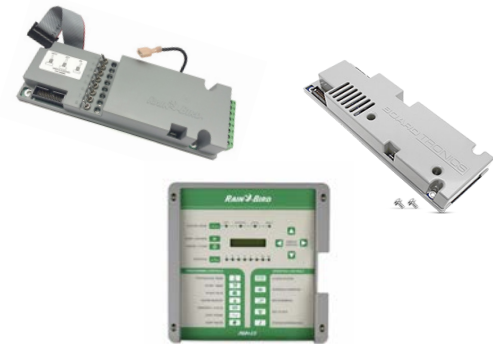

RAINBIRD SATELLITE CONTROLLERS	PAR PLUS ES	
STATION CAPACITY	Up to 72 (also available with decoders)	
CONFIGURATIONS	Stand Alone, 2-wire path, LINK system	
STATION LOAD CAPACITY	Up to 4 solenoids per station	
PROGRAMS	6 auto/2 manual, unlimited w/central	
MANUAL STATION OPERATION	1 to 16 station simultaneous	
AT-A-GLANCE STATION OPERATION	LCD displays active stations	

RAIN BIRD SATELLITES & PARTS	DESCRIPTION
AXPARPLUSES S	16 - 72 Station, Pedestal, Stand Alone w/switches
AXPARPLUSES2 S	16 - 72 Station, Pedestal, 2 wire 2/switches
AXLINK	Expands any of the above to wireless communication
AXHA0200	8 Station Expansion Module (OSM) w/switches
AXPARESKIT	Expansion Kit 49-72
AXP633226-02	Power Interconnect Board (PIB) for PAR+
AXP633226-03	Power Interconnect Board (PIB) for PAR+ES
AXP633176	Ribbon Cable for Face Plate to PIB
AXMAXI2WMOD	2-Wire Communication Module
AXH44550	Link Radio InterFace Module
AXP634875	Ribbon Cable from PIB to 2-Wire Communication Module
AXP635569	Ribbon Cable for PAR+ES Expansion Cable for 49 or more stations
AXMAXIMIMLOANER	Maxi Interface Module (Loaner)
AXMAXIDECODERINT	Maxi Decoder Interface (Loaner)

## Decoders

With all electronic components fully sealed within a water-tight enclosure and buried underground, damage from floods, frost, rodents or vandals is virtually eliminated. Rain Bird decoders are an especially good choice for flood plains.

### Features:

- Can be easily expanded.
- Less wire used than satellite systems.
- Low voltage and short-circuit detection.

RAIN BIRD DECODERS	DESCRIPTION	PRICE
AXFD101	Single station, individual head control	\$ 521.19
AXFD102	Single station, double head control	\$ 784.50
AXFD202	Double station, double head control	\$ 1,152.06
AXFD401	Four stations, individual head control w/LSP	\$ 1,536.74
AXFD601	Six stations, individual head control w/LSP	\$ 2,578.43
AXLSP-1	Line surge protection	\$ 263.47
AE270DCFD	Decoder Cable Fuse device, 2-way	\$ 353.43
AE270DCFD3	Decoder Cable Fuse device, 3-way	\$ 452.40





## Rain Bird Golf Rotors

The Rain Bird Golf Rotor has been and will continue to be the industry leader.

- True closed-case design with self flushing action
- Manual operation selector with optional quick-coupling feature
- Top-serviceable selector assembly and rock screen
- Reinforced case assembly with shovel guards for tubing
- Only available in ACME threads
- Rotors are typically factory set at 80 PSI



702/752 SERIES

## 702/752 Series Rotors

Nozzle Range (702: 59'- 77' 752: 19'- 84')



Model B: 1" ACME Inlet

Rotor warranty extended to 5 years if installed with Rain Bird swing joints

ROTORS	DESCRIPTION	BOX QTY.	PRICE
AX702B	Block - Full Circle	10	\$ 430.60
AX752B	Block - Full Circle	10	\$ 476.75



702/752 SERIES

## 702/752 Series Rotors

Nozzle Range (702: 59'-77' 752: 19'-84')



Models E & IC: 1.25" ACME Inlet

Rotor warranty extended to 5 years if installed with Rain Bird swing joints

ROTORS	DESCRIPTION	BOX QTY.	PRICE
AX702E	Electric - Full Circle	8	\$ 905.25
AX702IC	Integrated Control - Full Circle	8	\$ 1,454.21
AX752E	Electric - Full Circle, Adjustable 30° to 345°	8	\$ 1,030.13
AX752IC	Integrated Control - Full Circle, Adjustable 30° to 345°	8	\$ 1,561.87



900 SERIES

## 900/950 Series Rotors -

Nozzle Range (63'-97')

1-1/2" ACME Inlet



Rotor warranty extended to 5 years if installed with Rain Bird swing joints

ROTORS	DESCRIPTION	BOX QTY.	PRICE
AX900E	Electric - Full Circle	4	\$ 914.95
AX900IC	Integrated Control - Full Circle	4	\$ 1,399.92
AX950E	Electric - Part Circle	4	\$ 1,011.82
AX950IC	Integrated Control - Part Circle	4	\$ 1,507.62



### Rain Bird Sod Cup Kit

Enhance the overall appearance of your course while eliminating potential rotor interference with this kit. Designed to allow turf growth directly on top of the head, the Sod Cup Kit can be easily installed on existing Rain Bird rotors to reduce their visibility for seamless turf presentation with improved playability.

### Rain Bird Sod Cup Kit

PART #	DESCRIPTION	PRICE
AXP212613	Rain Bird Sod Cup for 551/750/751 rotors	\$ 254.33





## Rotor Nozzles Specifications at 80 PSI



	PART #	GPM	FT	NUMBER	COLOUR	PRICE	
551	AXP213500-51	8.60	36	#51	BLUE	\$ 11.25	
	AXP213500-52	8.73	40	#52	BEIGE	\$ 11.25	
	AXP213500-53	11.80	51	#53	GRAY	\$ 11.25	
	AXP213500-54	12.26	53	#54	RED	\$ 11.25	
700/ 702	AXP213700-28	21.5	62	#28	WHITE	\$ 10.46	
	AXP213700-32	25	67	#32	BLUE	\$ 10.46	
	AXP213700-36	28.3	70	#36	YELLOW	\$ 10.46	
	AXP213700-40	30.6	72	#40	ORANGE	\$ 10.46	
	AXP213700-44	33.9	75	#44	GREEN	\$ 10.46	
751/ 752	AXP213700-48	37.5	74	#48	BLACK	\$ 10.46	
	AXP213751-18**	8.1	31	#18	BEIGE	\$ 10.29	
	AXP213751-20**	8.9	41	#20	GRAY	\$ 10.29	
	AXP213751-22**	10.8	43	#22	RED	\$ 10.29	
	AXP213751-24**	10.2	48	#24	PLUM	\$ 10.29	
	AXP213751-26**	11.6	51	#26	LT. GREEN	\$ 10.29	
	AXP213750-28	19.3	59	#28	WHITE	\$ 10.29	
	AXP213750-32	21.4	61	#32	BLUE	\$ 10.29	
	AXP213750-36	24	67	#36	YELLOW	\$ 10.29	
	AXP213750-40	27.5	71	#40	ORANGE	\$ 10.29	
900	AXP213750-44	30.4	71	#44	GREEN	\$ 10.29	
	AXP213750-48	33.7	73	#48	BLACK	\$ 10.29	
	AXP213751-50	41.9	81	#50	BROWN	\$ 10.29	
	AXP211697	750 CASCADE					\$ 31.76
	AXP212287	750 DUAL SPREADER					\$ 36.49
	950	AXP213900-44	24.7	71	#44	BLUE	\$ 10.29
		AXP213900-48	34.1	75	#48	YELLOW	\$ 10.29
		AXP213900-52	37.1	81	#52	ORANGE	\$ 10.29
		AXP213900-56	43.5	85	#56	GREEN	\$ 10.29
		AXP213900-60	46.4	91	#60	BLACK	\$ 10.29
AXP213900-64		51	93	#64	RED	\$ 10.29	
950	AXP213950-18	22.9	74	#18	WHITE	\$ 10.80	
	AXP213950-20	27	76	#20	GRAY	\$ 10.80	
	AXP213950-22	30.9	80	#22	BLUE	\$ 10.80	
	AXP213950-24	36	84	#24	YELLOW	\$ 10.80	
	AXP213950-26	41.5	84	#26	ORANGE	\$ 10.80	
	AXP213950-28	47.3	86	#28	GREEN	\$ 10.80	
	AXP213950-30	50.4	86	#30	BLACK	\$ 10.80	
	AXP213950-32	53.1	85	#32	BROWN	\$ 10.80	
	AXP211900	EAGLE TAIL KIT FOR 950				\$ 56.56	

### WIND TOLERANT NOZZLE KIT

700/ 702	AXP21286216WT	18.1	59	#16	GRAY	\$ 110.02
	AXP21286218WT	21.5	62	#18	RED	\$ 110.02
	AXP21286222WT	30.1	64	#22	BLACK	\$ 110.02
751/ 752	AXP21293316WT	17.8	62	#16	GRAY	\$ 107.96
	AXP21293318WT	21.4	65	#18	RED	\$ 107.96
	AXP21293322WT	35.8	65	#22	BLACK	\$ 107.96

### LOW ANGLE NOZZLE KIT

751/ 752	AXP213880-20**	8.9	34	#20	GRAY	\$ 48.46
	AXP213880-22**	10.8	41	#22	RED	\$ 48.46
	AXP213880-28	19.3	55	#28	WHITE	\$ 48.46
	AXP213880-32	21.4	61	#32	BLUE	\$ 48.46
	AXP213880-36	24	67	#36	YELLOW	\$ 48.46
	AXP213880-40	27.5	67	#40	ORANGE	\$ 48.46
	AXP213880-44	30.4	71	#44	GREEN	\$ 48.46
	AXP213880-48	33.7	73	#48	BLACK	\$ 48.46

(\*\*) indicates low flow valve

Parts Discount applies on Golf Rotor Nozzles



## Rotor Common Parts

\*\* Parts Discount \*\*

INTERNALS	PART #	PRICE
551	AXP214551	\$ 231.45
700	AXP214700	\$ 202.38
751	AXP214751	\$ 236.82
900	AXP210786	\$ 263.72
950	AXP211442	\$ 328.33
SNAP RINGS - TOP		
500 - 700	AXP211921-01	\$ 22.08
900 - 950	AXP211934-01	\$ 29.33
CASE ASSEMBLY		
500 - 700	AXP21246603C	\$ 495.15
900	AXP212475-03	\$ 500.53
500 - 700 (BLOCK)	AXP211489-01	\$ 83.25
VALVES		
500 - Bottom Valve	AXP212089	\$ 145.32
700 - Bottom Valve	AXP211468	\$ 139.94
900 - 1100 - Bottom Valve	AXP211266	\$ 156.10
500 - 700 Snap Rings	AXP210470	\$ 9.47
900 - 1100 Snap Rings	AXP208396	\$ 10.98

O-RINGS	PART #	PRICE
500 - 700	AXP211242	\$ 15.62
900/1100	AXP212383	\$ 16.70
MISC. PARTS		
MISC. PARTS	PART #	PRICE
PRS Cartridge (pre 4/01)	AXP213366	\$ 101.92
PRS Cartridge (post 4/01)	AXP212150	\$ 104.43
Selector Assembly	AXP211418	\$ 188.40
Selector Seal (rust)	AXP211663	\$ 11.88
IC Module	AXICM	\$ 438.90
Green Solenoid	AXP602118	\$ 79.67
Black Solenoid	AXP213462C	\$ 67.83
Quick Connects	AXP212159	\$ 16.69

## Rotor Tools

PART #	DESCRIPTION	NET PRICE
AXD02237	Rock Screen Removal Tool	\$ 20.46
AXSVKE	Selector Service Tool	\$ 20.46
AXDR-SVK-18	Valve Selector Key (18")	\$ 77.30
AXDR-SVK-7	Valve Selector Key (7")	\$ 43.07
AXSRP	Snap Ring Pliers (900)	\$ 123.80
AXSRPE7	Snap Ring Pliers (700/750)	\$ 95.15
AXVT900D	Valve Insertion Tool (900)	\$ 150.71
AXVTE7	Valve Insertion Tool (700)	\$ 138.75
AXUHA	Universal Hose Adapter	\$ 130.82

PART #	DESCRIPTION	NET PRICE
OETTRT100	Turbo Trimmer Ratcheting (no blade)	\$ 185.01
OETTRC007	7" Turbo Trimmer Blade	\$ 70.01
OETTRC008	8" Turbo Trimmer Blade	\$ 70.01
OEAERR	T Handle Valve Selector for Rain Bird	\$ 37.00
OEASKTRB	9 in 1 tool for Golf Rotors	\$ 30.01
OEHNR125S	Hose Tap for Rain Bird 700 Series	\$ 98.01
OEHNR150S	UHA Kit for Rain Bird 900 Series	\$ 98.01
MBTK300	Turf Knife	\$ 13.85
OEHNT100S	Hose Tap for Toro 630	\$ 98.01
OEHNT150S	Hose Tap for Toro 650	\$ 98.01





**LEASE ME!**  
 FLEXIBLE LEASING OPTIONS  
 AVAILABLE FOR YOU!  
 CONTACT YOUR SALES REP.

## WX Line Lightning Warning System



## Solar Power Options for Sirens and Strobes

### Features

- Fully automatic alarm triggering with user-set range categories
- 20 mile detection range
- No false alarms. Patented technology
- Sensor and communication self-test
- Sensor is battery-powered for easy installation
- Durable fiber-optic communications with connector-less technology
- NEMA 4X Sensor enclosure
- Lightning Data Receiver with battery back-up
- Optional, Strike View Software for Windows® and Macintosh®
- Strike Guard Simulator Software for training and testing

## Make Safety a Priority

The Strike Guard Lightning Warning System interfaces to the WAVE product line to provide fully automated operation of audible and visual lightning notification and lightning equipment protection schemes. The Strike Guard Lightning Data Receiver's contact signals communicate with the WAVE Transmitter to send encoded alarm and all-clear messages via RF to the remote WAVE Siren Stations and WAVE Sequencers.

The intelligent design of the Strike Guard Lightning Warning System and WAVE products make for an unbeatable combination of innovation and value.



# HARCO FITTINGS

Providing a newly expanded product line for the golf course irrigation industry

- Ductile Iron Fittings and Restraints
- PVC Pressure Fittings
- HDPE Fittings
- Compression Fittings for HDPE pipe
- Stainless Steel Lateral Isolation Valves

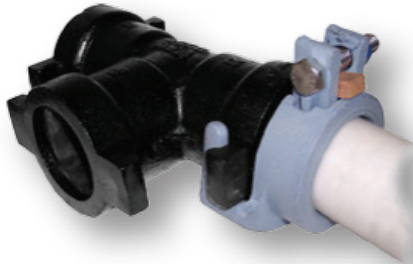

THE HARRINGTON CORPORATION

Lynchburg, VA ♦ (434) 845-7094

[www.harcofittings.com](http://www.harcofittings.com) ♦ [sales@harcofittings.com](mailto:sales@harcofittings.com)

## ALL OF YOUR IRRIGATION NEEDS



LASCO offers SCH 40, Inserts, Nipples, Valves, Repair Couplings, Swing Joints, Heavy Turf, Residential & Commercial Irrigation Products.

**LASCO**<sup>®</sup>  
*Fittings, Inc.*





## Impact Sprinklers



AX85ESHD

IMPACT SPRINKLERS		RANGE (FT)	FLOW (GPM)	PRICE
AX25BPJFPADJDAT	Brass, 1/2" MIPT F/P circle	36 - 45	1.5 - 8.4	POR
AX35A-PJ-ADJ-TNT	Brass, 3/4" MIPT, Part circle	42 - 51	4.2 - 7.8	POR
BEWR33	Brass, 3/4" MIPT, Full circle (nozzle extra) *	42 - 51	4.2 - 7.8	POR
AX65PJ-ADJ-TNT	Brass, 1" FIPT, F/P circle	57 - 65	12.9 - 16.5	POR
AX85ESHD	Brass, 1 1/4" MIPT, Dual nozzle F/P circle	61-116	17-128	POR

IMPACT NOZZLE CONVERSION CHART FOR 70S														
NEW STYLE	8	9	10	11	12	13	14	15	16	17	18	20	22	24
OLD STYLE	1/8	9/64	5/32	11/64	3/16	13/64	7/32	15/64	1/4	17/64	9/32	5/16	11/32	3/8

\*WR33 requires 1 nozzle BEPWR532

## Turf Valves



TURF VALVE (AX5RC)



VALVE KEY (AX55K)



SWIVEL HOSE ELBOW (AXSH2)

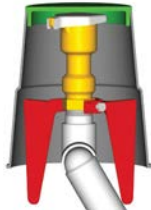

QUICK COUPLER STABILIZER

PART # - TURF VALVES	DESCRIPTION	PRICE
AX3RC	3/4" with rubber cover	\$ 156.00
AX44RC	1" x 3/4" with rubber cover	\$ 307.25
AX5RC	1" x 1" with rubber cover	\$ 263.34

PART # - VALVE KEYS	DESCRIPTION	PRICE
AX33K	3/4" MIPT on top for use with 3RC	\$ 104.00
AX44K	3/4" MIPT on top for use with 44RC	\$ 252.37
AX55K	1" MIPT on top for use with 5RC	\$ 268.83

PART # - HOSE ELBOWS	DESCRIPTION	PRICE
AXSH-0	3/4" FIPT x 3/4" MIHT	\$ 135.02
AXSH-1	1" FIPT X 3/4" MIHT	\$ 155.01
AXSH-2	1" FIPT x 1" MIHT	\$ 158.01

PART # - ACCESSORIES	DESCRIPTION	PRICE
MD82201	Quick coupler stabilizer	\$ 69.70

## Irrigation Accessories



HEAVY DUTY HOSE



OEH10100B



OENG450



POLY-FOG NOZZLE



KOCHEK



MCRB2210



MHGCCB37118L

PART # - HOSE	DESCRIPTION	NET PRICE
EGGH07550	3/4" X 50' Heavy Duty Hose	\$ 56.35
EGGH075100	3/4" x 100' Heavy Duty Hose	\$ 98.00
EGGH1100	1" x 100' Heavy Duty Hose	\$ 128.00
OEH10100B	1" x 100' Ultra MAX Blue Hose	\$ 325.00
PF075MXF-BS	3/4" Brass Couplers	\$ 10.00
PF100MXF-BS	1" Brass Couplers	\$ 14.00

PART # - HOSE NOZZLES	DESCRIPTION	NET PRICE
PFSL100-12G	3/4" Poly Fog nozzle (green)	\$ 17.00
PFSL100-16N	1" Poly Fog nozzle (red)	\$ 21.00
PFSL150-24N	1 1/2" Poly Fog nozzle (red)	\$ 17.00
PFP100W	1" Hose Washer	\$ 0.60
OENG450	3/4" MAGNUM Hose Nozzle	\$ 45.00
NDIRNZ009	1" Nozzle w/bumper (10-24GPM) - Kochek	\$ 126.00
NDIRNZ015	1" Nozzle w/bumper (20-60GPM) - Kochek	\$ 246.00

PART # - ROLLER BASES	DESCRIPTION	NET PRICE
MCRB2210	22" Aluminium Roller Base (1" FHT x 1" FIPT)	\$ 148.01

PART # - HOSE REELS	DESCRIPTION	PRICE
MHGCCB37118L	Hand Crank Hose Reel w/10' connection hose for 100' of hose	\$ 1,041.00
MHCA33112L	3/4" Hand Crank Reel Craft	\$ 636.00
MHCB37118L	1" Hand Reel Craft by 100'	\$ 718.00

# RAIN BIRD

## Rain Bird Swing Joints & Accessories

Looking to enhance the performance of your golf course irrigation system? Rain Bird swing joints are the perfect solution.

- Innovative elbow design reduces pressure loss by over 50%
- Excellent structural integrity from the swept elbow design reduces the costs associated with fatigue-related failures

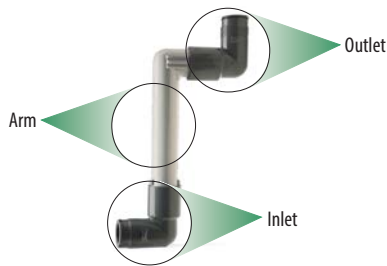

### Rain Bird Swing Joints

SWING JOINT	INLET	ARM	OUTLET	PRICE
AXTSJ12	1" MIPT	1" x 12"	1" MIPT	\$ 56.83
AXSJ1210016	1" MIPT	1" x 12"	1 1/4" ACME	\$ 62.85
AXSJ1215013	1 1/2" MIPT	1 1/2" x 12"	1 1/2" ACME	\$ 102.36
AXSJ12125R3	1 1/2" ACME	1 1/4" x 12"	1 1/4" ACME	\$ 96.89
AXSJ1215033	1 1/2" ACME	1 1/2" x 12"	1 1/2" ACME	\$ 102.36



### Rain Bird Swing Joint Adapters

SWING ADAPTERS	DESCRIPTION	PRICE
AXSJP213370-02	Adapter NPT x ACME 1 1/4"	\$ 11.68
AXSJP213370-03	Adapter NPT x MACME 1 1/2"	\$ 14.37

\*\* Parts Discount \*\*



### PVC Saddles & Tap Tees

HARCO ACME TAP TEES (GASKET X ACME)	CASE QTY.	PRICE
MD153-206	2" x 1 1/2"	16 \$ 98.02
MD153-256	2 1/2" x 1 1/2"	16 \$ 131.01
MD153-306	3" x 1 1/2"	16 \$ 175.79



WEDGE PLASTIC SADDLE TEES FOR PVC IRRIGATION	DESCRIPTION	CASE QTY.	PRICE
FLSADP21	2" x 1"	SADDLE TEE WEDGE 5	\$ 95.00
FLSADP215	2" x 1 1/2"	SADDLE TEE WEDGE 5	\$ 95.00
FLSADP2515	2 1/2" x 1 1/2"	SADDLE TEE WEDGE 5	\$ 110.00
FLSADP31	3" x 1"	SADDLE TEE WEDGE 5	\$ 130.00
FLSADP32	3" x 2"	SADDLE TEE WEDGE 5	\$ 130.00
FLSADP42	4" x 2"	SADDLE TEE WEDGE 5	\$ 160.00
FLSADP62	6" x 2"	SADDLE TEE WEDGE 5	\$ 225.00
FLSADP82	8" x 2"	SADDLE TEE WEDGE 5	\$ 275.00

BOLT-ON PLASTIC SADDLE TEES FOR PVC IRRIGATION	DESCRIPTION	CASE QTY.	PRICE
BA361-211	1 1/2" x 1"	SADDLE X SOC 5	\$ 47.41
BA364-251	2" x 1 1/2"	SADDLE X ACME 5	\$ 59.81
BA364-337	3" x 1 1/2"	SADDLE X ACME 5	\$ 81.65
BA364-419	4" x 1 1/2"	SADDLE TAPPED 5	\$ 98.85



Designing or building, a golf course, sports field, or other turf project? LASCO is the name you turn to for Swing Joint Solutions.

\*\* For more swing joint options visit  
[www.lascofittings.com](http://www.lascofittings.com)

- Ease of maintenance and adjustments to rotor settling or turf height
- Allow rotor to be positioned vertically and horizontally for exact grade alignment

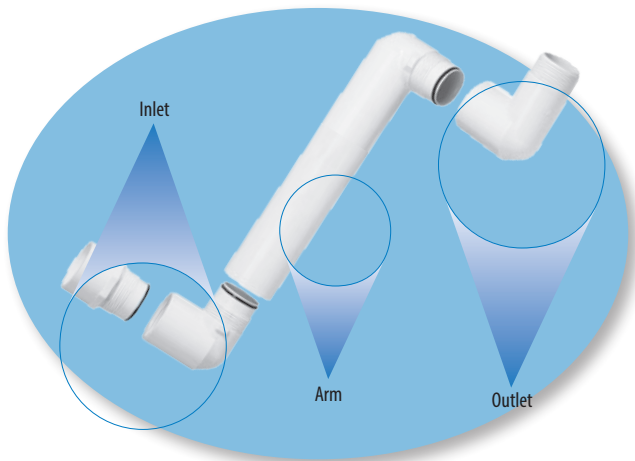

## Lasco Swing Joints

PART #	INLET	ARM	OUTLET	PRICE
BAT532-208	½" MIPT	1/2" x 8"	½" MIPT	\$ 72.80
BAG132212	1" MIPT	1" x 12"	1" MIPT	\$ 61.31
BAG130212	1" MIPT	1" x 12"	1" ACME	\$ 64.07
BAG13A212	1" MIPT	1" x 12"	1¼" ACME	\$ 64.07
BAG138212	1" MIPT	1" x 12"	1½" ACME	\$ 58.24
BAG332212	1½" MIPT	1½" x 12"	1½" MIPT	\$ 903.36
BAG330212	1½" MIPT	1½" x 12"	1½" ACME	\$ 103.36
BAG34A212	1½" ACME	1½" x 12"	1¼" ACME	\$ 103.36
BAG3M0212	1½" ACME	1½" x 12"	1½" ACME	\$ 103.36

## Quick Coupler Swing Joints

PART #	INLET	ARM	OUTLET	PRICE
BAG13S212	1" MIPT	1" x 12"	1" BRASS	\$ 130.65
BAD1A111118 (DURA)	1" MIPT	1" X 18"	1" BRASS	\$ 186.00
BAD1A111112 (DURA)	1" MIPT	1" X 12"	1" BRASS	\$ 179.00
BAG13S218	1" MIPT	1" X 18"	1" BRASS	\$ 137.58

## Elbows



PART #	INLET (F)	OUTLET (M)	PRICE
BAG001011	1" ACME	1" BRASS	\$ 46.12
BAG100002	1" ACME	1" ACME	\$ 18.03
BAG102000	1" ACME	1" MIPT	\$ 7.83
BAG108132	1" ACME	1¼" ACME	\$ 21.89
BAG108211	1" ACME	1½" ACME	\$ 21.89
BAG300002	1½" ACME	1½" ACME	\$ 31.40
BAG302000	1½" ACME	1½" MIPT	\$ 17.13
BAG302133	1½" ACME	1" MIPT	\$ 28.12
BAG308-133	1½" ACME	1" ACME	\$ 28.12
BAG308212	1½" ACME	1¼" ACME	\$ 28.12

## Inlet Nipples



PART #	INLET (M)	OUTLET (M)	PRICE
BAG130000	1" ACME	1½" ACME	\$ 8.76
BAG001004	1½" ACME	1½" ACME	\$ 14.27
BAG001014	1½" ACME	1" ACME	\$ 8.76
BAG001016	1½" ACME	1¼" ACME	\$ 10.75



## ACME Caps

PART #	INLET	PRICE
BAG548012	1¼" ACME	\$ 5.09
BAG548015	1½" ACME	\$ 5.48



## Swing Joint Adapters

PART #	INLET (F)	OUTLET (M)	PRICE
BAG002-132	1" FIPT	1¼" ACME	\$ 12.58
BAG002212	1½" FIPT	1¼" ACME	\$ 12.58
BAG102010	1" FIPT	1" ACME	\$ 9.14
BAG302015	1½" FIPT	1½" ACME	\$ 13.42
BA539212	1¼" ACME	1½" ACME	\$ 14.36

## Swing Joint Extensions



PART #	INLET	PRICE
BAG587003	1¼" SJ Extension	\$ 17.26
BAG587001	1½" SJ Extension	\$ 22.79



## PVC Service Tees & Elbows

SERVICE ELBOWS (SLIP X FACME)	BOX QTY.	PRICE
BA307-251	2" x 1½"	10 \$ 16.93
BA307-291	2½" x 1½"	5 \$ 22.97
BA307-337	3" x 1½"	5 \$ 46.79

SERVICE TEES (SLIP X FACME X SLIP)	BOX QTY.	PRICE
BA302-251	2" x 2" x 1½"	10 \$ 21.17
BA302-291	2½" x 1½"	5 \$ 30.46
BA302-337	3" x 3" x 1½"	5 \$ 62.93



HARCO offers fittings for HDPE pipe starting at 1/2" through 36" +. Both IPS and DIPS available, as well as FM fittings. HARCO has developed a set of sources with long and proven experience in the manufacture of pipe fittings for HDPE pipe. We offer special fittings for irrigation applications utilizing our Swivel and Lateral Isolation Valve Products.

### TEE



PART #	SIZE	PRICE
MD8030303	3"	\$ 418.25
MD8040404	4"	\$ 540.00
MD8060606	6"	\$ 868.25
MD8080808	8"	\$ 1,260.03

### 90 ° ELBOW



PART #	SIZE	PRICE
MD80320	3"	\$ 296.51
MD80420	4"	\$ 346.26
MD80620	6"	\$ 686.15
MD80820	8"	\$ 884.14

### REDUCING TEE



PART #	SIZE	PRICE
MD8030301	3" x 2"	\$ 501.91
MD8040403	4" x 3"	\$ 534.74
MD8060603	6" x 3"	\$ 682.94
MD8060604	6" x 4"	\$ 817.44
MD8080806	8" x 6"	\$ 1,249.43

### 22 1/2 ° ELBOW



PART #	SIZE	PRICE
MD80424	4"	\$ 318.71
MD80624	6"	\$ 439.44

### REDUCER BUSHING

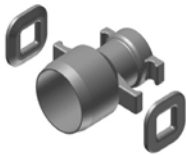

PART #	SIZE	PRICE
MD80332	3" x 2"	\$ 259.60
MD80434	4" x 2"	\$ 227.68
MD80430	4" x 3"	\$ 232.94
MD80632	6" x 4"	\$ 400.24
MD80832	8" x 6"	\$ 472.25

### 45 ° ELBOW



PART #	SIZE	PRICE
MD80322	3"	\$ 260.48
MD80422	4"	\$ 318.70
MD80622	6"	\$ 518.85
MD80822	8"	\$ 670.33

### HARCO SWIVEL VALVES



	PRICE
MD8411062PL 2" 90° Swivel Valve	\$ 1,088.48
MD8412062PL 2 1/2" 90° Swivel Valve	\$ 1,402.96
MD8413062PL 3" 90° Swivel Valve	\$ 1,577.68
MD8414062PL 4" 90° Swivel Valve	\$ 1,768.62

\*\* STAINLESS STEEL \*\*

### COUPLINGS



PART #	SIZE	PRICE
MD80340	3"	\$ 254.13
MD80440	4"	\$ 322.96
MD80640	6"	\$ 497.66
MD80840	8"	\$ 619.42

### SWIVEL TEE & EXTENSIONS



	PRICE
MD8045405 Swivel Tee 4"	\$ 397.07
MD8065405 Swivel Tee 6"	\$ 513.56
MD87106 6" Swivel Riser Extension	\$ 103.77
MD87112 12" Swivel Riser Extension	\$ 166.24

### HARCO REPAIR COUPLERS



	CASE QTY.	PRICE
MD109-015 1 1/2"	24	\$ 62.12
MD109-020 2"	24	\$ 68.14
MD109-025 2 1/2"	24	\$ 74.93
MD109-030 3"	24	\$ 93.75
MD109-040 4"	12	\$ 168.62
MD109-060 6"	6	\$ 296.40
MD109-080 8"	4	\$ 610.53
MD109-100 10"	1	\$ 1,130.63

### PVC SERVICE TEES



	PRICE
MD153-206 2" x 1 1/2" G x ACME	\$ 98.02
MD153-256 2 1/2" x 1 1/2" G x ACME	\$ 131.01
MD153-306 3" x 1 1/2" G x ACME	\$ 175.79

See page 31 for repair couplings.



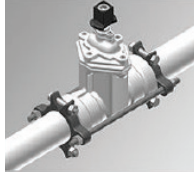

VALVE TO PIPE RESTRAINT		PRICE
MD820125	2"	\$ 609.92
MD820225	2 1/2"	\$ 663.91
MD820325	3"	\$ 695.65
MD820425	4"	\$ 810.03
MD820625	6"	\$ 1,001.66
MD820825	8"	\$ 1,254.73
MD821025	10"	\$ 1,683.54



FITTING TO PIPE RESTRAINT		PRICE
MD820110	2"	\$ 190.61
MD820210	2 1/2"	\$ 209.67
MD820310	3"	\$ 227.68

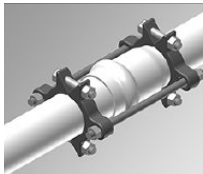

PIPE TO PIPE RESTRAINT		PRICE
MD820315	3"	\$ 429.91

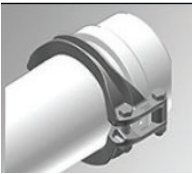

FITTING TO PIPE RESTRAINT CLAMSHELL STYLE		PRICE
MD820411	4"	\$ 296.50
MD820611	6"	\$ 381.18
MD820811	8"	\$ 513.55
MD821011	10"	\$ 695.65



FITTING TO VALVE TO PIPE		PRICE
MD820321	3"	\$ 584.50
MD820421	4"	\$ 645.90
MD820621	6"	\$ 751.80
MD820821	8"	\$ 857.66



VALVE TO FITTING RESTRAINT		PRICE
MD820320	3"	\$ 162.01
MD820420	4"	\$ 171.95

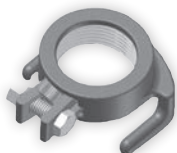

KNUCKLE RESTRAINTS		PRICE
MD60-100-02	2"	\$ 124.94
MD60-100-25	2 1/2"	\$ 135.03
MD60-100-03	3"	\$ 145.00
MD60-100-04	4"	\$ 238.03



CONNECTION LINKS & WEDGES		PRICE
MD82000	up to 8"	\$ 39.18

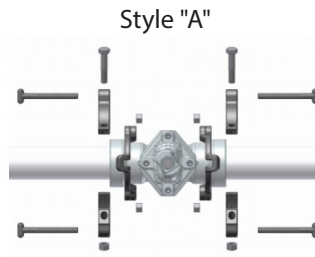

Style "A"

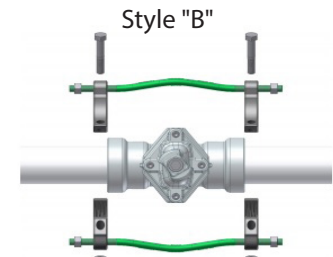

Style "B"

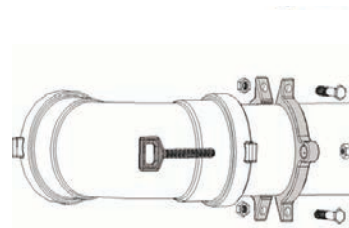

CLAMSHELL

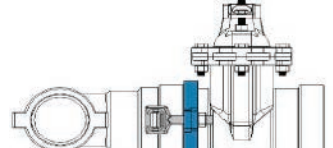
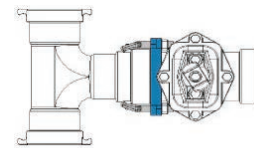
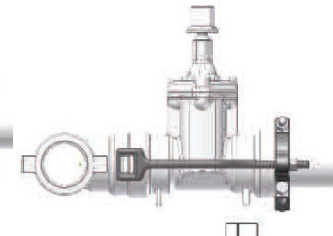
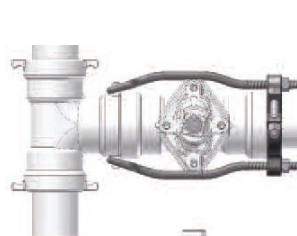

### KNUCKLE RESTRAINTS

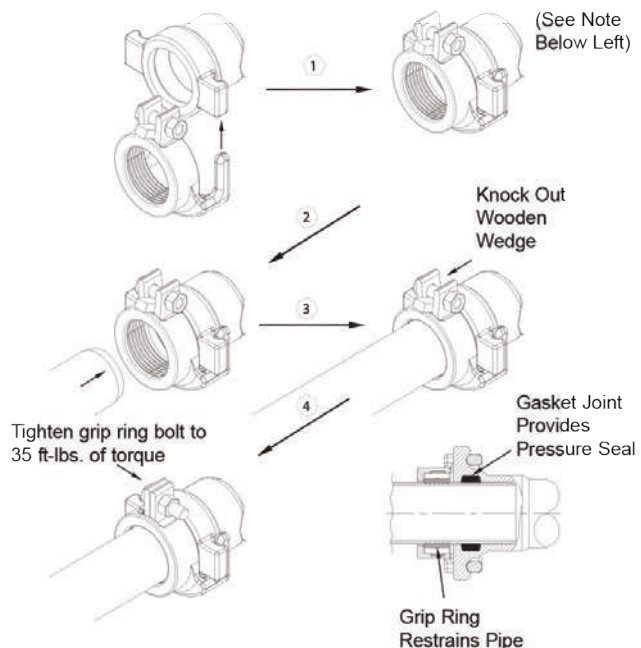

## PHILMAC Fittings



PHILMAC ADAPTERS	PRICE
MD75-33044 1" Male Adapter	\$ 21.10
MD75-33066 1½" Male Adapter	\$ 40.02
MD77-33088 2" Male Adapter	\$ 56.51
MD75-33244 1" Female Adapter	\$ 30.03
MD75-33266 1½" Female Adapter"	\$ 53.02
MD77-33288 2" Female Adapter	\$ 85.04
MD77-33386 2" x 1½" Service Adapter	\$ 61.57



PHILMAC TEES	PRICE
MD75-312444 1" Tee	\$ 48.02
MD75-312666 1½" Tee	\$ 107.01
MD77-312888 2" Tee	\$ 165.02
MD75-351442 1 x 1½" Service Tee	\$ 50.03
MD75-351444 1" Service Tee	\$ 46.65
MD75-351666 1½" Service Tee	\$ 83.01
MD77-353886 2" x 1½" Service Tee	\$ 75.99
MD77-351888 2" Service Tee	\$ 76.01



PHILMAC END CAPS	PRICE
MD75-3494 1" End Cap	\$ 27.52
MD75-3496 1½" End Cap	\$ 57.01
MD77-3498 2" End Cap	\$ 79.02



PHILMAC ELBOWS	PRICE
MD75-31844 1" Elbow	\$ 35.03
MD75-31866 1½" Elbow	\$ 82.00
MD77-31888 2" Elbow	\$ 110.04
MD77-32386 2" x 1½" Service Elbow	\$ 70.02
MD77-32088 2" Service Elbow	\$ 125.01



PHILMAC COUPLINGS	PRICE
MD75-30844 1" Coupling	\$ 34.02
MD75-30866 1½" Coupling	\$ 69.03
MD77-30888 2" Coupling	\$ 99.00
MD77-30988 2" Coupling w/o stop	\$ 99.00

HARCO offers fittings for HDPE pipe starting at ½" through 36"+. Both IPS and DIPS available as well as FM fittings. HARCO has developed a set of sources with long and proven experience in the manufacture of pipe fittings for HDPE pipe. The special fittings for irrigation applications utilize the Swivel and Lateral Isolation Valve Products.

# Now available MOBILE APP 2.0

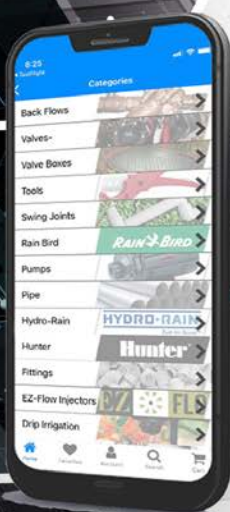

- Live and up-to-date with internal data base
- Pricing more current and up-to-date
- Improved order tracking
- More detailed order status updates





# Isolation Valves

# NIBCO



NIBCO Push on Gate Valve

NIBCO PUSH ON GATE VALVES		PRICE
TF619RW-2	2" Push on Gate Valve	\$ 777.56
TF619RW-25	2½" Push on Gate Valve	\$ 799.69
TF619RW-3	3" Push on Gate Valve	\$ 857.67
TF619RW-4	4" Push on Gate Valve	\$ 1,111.53
TF619RW-6	6" Push on Gate Valve	\$ 1,654.08
TF619RW-8	8" Push on Gate Valve	\$ 2,507.05

\*\* Lead time on orders may vary. \*\*

# AVR



AVK Ringtite Valve

### Features:

- For PVC pipe, resilient-wedge, non-rising stem
- Rubber gasketed joints compensate for expansion, contraction and normal stresses
- Working pressure: 250 psi W.O.G.
- Flange available as special order

AVK CAST IRON GATE VALVES		PRICE
TFAVK2	2" Ringtite valve	\$ 971.75
TFAVK25	2½" Ringtite valve	\$ 1,293.50
TFAVK3	3" Ringtite valve	\$ 1,355.25
TFAVK4	4" Ringtite valve	\$ 1,446.25
TFAVK6	6" Ringtite valve	\$ 2,005.25
TFAVK8	8" Ringtite valve	\$ 3,425.50

Ask us about HDP parts. Available upon request.



AVK Valve Control Key

GATE VALVE - TOOLS		PRICE
TF403RT-KEY	Valve control key	\$ 113.17

# Mueller Canada



MUELLER Wedge Gate Valve

MUELLER CANADA RESILIENT WEDGE GATE VALVE		PRICE
TFMUELLER2	2" Threaded Gate Valve	POR
TFMUELLER4	4" Threaded Gate Valve	POR
TFMUELLER6	6" Threaded Gate Valve	POR
TFMUELLER8	8" Threaded Gate Valve	POR

\*\* Lead time on orders may vary. \*\*



## QUALITY IRRIGATION PIPING

IPEX CycleTough® irrigation (Series 160 and Series 200) piping has remained the preferred brand of PVC piping in Canada for over 30 years. Here's why...

- Certified to CSA B137.3
- 160 psi or 200 psi options
- Sizes 1-1/2" to 24"
- Solvent-weld or gasket joint
- Easy to install, zero maintenance
- Made in Canada

So for your next irrigation project, ensure the underground piping meets the same high standard as what's growing above ground. Ask for IPEX. For more information on IPEX CycleTough pipe and fittings, please visit our website at [ipexna.com](http://ipexna.com).

[ipexna.com](http://ipexna.com) | 1-866-473-9462



CycleTough® is a registered trademark.





**IPEX**

All PVC pipe orders shipped by VBI will have a delivery charge.

Whatever your installation needs are, we have many different varieties, schedules and classes of high quality PVC irrigation pipe & sleeving. Our massive inventory of pipe is second to none and we will go the distance to satisfy all of your piping needs.

**SDR-26 (CLASS 160) PRESSURE PIPE - 160 PSI RATED - 20' LENGTHS**

PART #	CONNECTION TYPE	SIZE	SKID QTY.	PRICE / FOOT
ETA160-150	BELL END	1½"	4420	POR
ETA160-200	BELL END	2"	2800	POR
ETA160-250	BELL END	2½"	1560	POR
ETA160-300	BELL END	3"	1560	POR
ETA160-400	BELL END	4"	1200	POR
ETA160G-300	GASKET JOINT	3"	1560	POR
ETA160G-400	GASKET JOINT	4"	1200	POR
ETA160G-600	GASKET JOINT	6"	520	POR
ETA160G-800	GASKET JOINT	8"	280	POR
ETA160G-1000	GASKET JOINT	10"	240	POR
ETA160G-1200	GASKET JOINT	12"	160	POR

**SDR-21 (CLASS 200) PRESSURE PIPE - 200 PSI RATED - 20' LENGTHS**

PART #	CONNECTION TYPE	SIZE	SKID QTY.	PRICE
ET200-075	BELL END	¾"	4400	POR
ET200-100	BELL END	1"	3600	POR
ET200-125	BELL END	1¼"	3300	POR
ET200-200	BELL END	2"	2800	POR
ET200-250	BELL END	2½"	1560	POR
ET200-300	BELL END	3"	1560	POR
ET200G-200	GASKET JOINT	2"	2800	POR
ET200G-250	GASKET JOINT	2½"	1560	POR
ET200G-300	GASKET JOINT	3"	1560	POR
ET200G-400	GASKET JOINT	4"	1200	POR
ET200G-600	GASKET JOINT	6"	520	POR
ET200G-800	GASKET JOINT	8"	280	POR
ET200G-1000	GASKET JOINT	10"	240	POR

**SCHEDULE 40 PRESSURE PIPE - 10' LENGTHS**

PART #	CONNECTION TYPE	SIZE	SKID QTY.	PRICE
ET40-075	BELL END	¾"	2920	POR
ET40-100	BELL END	1"	2280	POR
ET40-125	BELL END	1¼"	1960	POR
ET40-150	BELL END	1½"	1510	POR
ET40-200	BELL END	2"	1050	POR

**SLEEVING/DRAINAGE - 10' LENGTHS**

PART #	CONNECTION TYPE	SIZE	SKID QTY.	PRICE
ET42325	BELL END	3"	1120	POR
ET40045	BELL END	4"	630	POR

**PIPE LUBRICANT**

PART #	DESCRIPTION	PRICE
ETLUBE-Q	GASKET JOINT LUBRICANT	\$ 10.25

**TOOLS**

PART #	DESCRIPTION	NET PRICE
ETBEVELPVC	PVC PIPE BEVELING TOOL FOR PIPE UP TO 4"	\$ 400.00



Beveling Tool

**Extra Discount Available  
for Ordering in Skid Quantities.**

Please note that PVC prices may change without notice. Please check with the VBI order desk for more information.



## Glue & Primer



IPEX 711 GREY GLUE			
PART NO.	SIZE	CASE QTY.	PRICE
ET711GL	Gallon	6	\$ 142.68
ET711QT	Quart	12	\$ 43.36
ET711PT	Pint	12	\$ 25.28
ET711HP	Half-pint	24	\$ 14.27



IPEX P70 PURPLE PRIMER			
PART NO.	SIZE	CASE QTY.	PRICE
ET70GL	Gallon	6	\$ 110.70
ET70QT	Quart	12	\$ 33.39
ET70PT	Pint	12	\$ 20.73
ET70HP	Half-pint	24	\$ 12.00

### IPEX 725 WET & DRY GLUE (BLUE GLUE)

ET725QT	Quart	12	\$ 37.39
ET725PT	Pint	12	\$ 23.19

### IPEX ACCESSORIES

ET074317	4" Roller for Quart Cans		\$ 29.58
ETDQ-150	Cap Dauber for Quart Cans		\$ 2.00
ETDP75	Cap Dauber for Half Pint Cans		\$ 1.93



www.lascofittings.com

## Schedule 40 Fittings

### TEE SLIP X SLIP

PART NO.	SIZE "	BOX QTY.	PRICE EACH
BA401-005	1/2	50	\$ 0.97
BA401-007	3/4	50	\$ 1.09
BA401-010	1	50	\$ 2.06
BA401-012	1 1/4	25	\$ 3.19
BA401-015	1 1/2	25	\$ 3.89
BA401-020	2	25	\$ 5.65
BA401-025	2 1/2	10	\$ 18.59
BA401-030	3	10	\$ 24.43
BA401-040	4	5	\$ 44.14
BA401-060	6	4	\$ 148.60
BA401-080	8	2	\$ 344.57



### REDUCING TEE SLIP X SLIP

PART NO.	SIZE "	BOX QTY.	PRICE EACH
BA401-101	3/4 x 3/4 x 1/2	50	\$ 1.28
BA401-130	1 x 1 x 1/2	50	\$ 2.18
BA401-131	1 x 1 x 3/4	50	\$ 2.37
BA401-167	1 1/4 x 1 1/4 x 3/4	25	\$ 3.49
BA401-168	1 1/4 x 1 1/4 x 1	25	\$ 3.49
BA401-209	1 1/2 x 1 1/2 x 1/2	25	\$ 6.14
BA401-210	1 1/2 x 1 1/2 x 3/4	25	\$ 6.14
BA401-211	1 1/2 x 1 1/2 x 1	25	\$ 6.14
BA401-212	1 1/2 x 1 1/2 x 1 1/4	25	\$ 6.14
BA401-213	1 1/2 x 1 1/2 x 2	25	\$ 8.78
BA401-247	2 x 2 x 1/2	10	\$ 6.07
BA401-248	2 x 2 x 3/4	10	\$ 6.07
BA401-249	2 x 2 x 1	10	\$ 6.07
BA401-250	2 x 2 x 1 1/4	10	\$ 6.07
BA401-251	2 x 2 x 1 1/2	10	\$ 6.07
BA401-289	2 1/2 x 2 1/2 x 1	10	\$ 18.56



### REDUCING TEE SLIP X SLIP

PART NO.	SIZE "	BOX QTY.	PRICE EACH
BA401-291	2 1/2 x 2 1/2 x 1 1/2	10	\$ 18.56
BA401-292	2 1/2 x 2 1/2 x 2	10	\$ 18.56
BA401-334	3 x 3 x 3/4	10	\$ 26.55
BA401-335	3 x 3 x 1	10	\$ 26.55
BA401-336	3 x 3 x 1 1/4	10	\$ 26.55
BA401-337	3 x 3 x 1 1/2	10	\$ 26.55
BA401-338	3 x 3 x 2	10	\$ 26.51
BA401-416	4 x 4 x 3/4	4	\$ 44.14
BA401-417	4 x 4 x 1	5	\$ 44.14
BA401-420	4 x 4 x 2	5	\$ 44.14
BA401-422	4 x 4 x 3	5	\$ 44.14
BA401-528	6 x 6 x 2	5	\$ 148.60
BA401-530	6 x 6 x 3	5	\$ 148.60
BA401-532	6 x 6 x 4	5	\$ 148.60
BA401-582	8 x 8 x 4	2	\$ 344.57
BA401-585	8 x 8 x 6	2	\$ 344.57

### TEE SLIP X FIPT

PART NO.	SIZE "	BOX QTY.	PRICE EACH
BA402-005	1/2	50	\$ 1.28
BA402-007	3/4	50	\$ 1.97
BA402-010	1	50	\$ 3.65
BA402-012	1 1/4	25	\$ 5.77
BA402-015	1 1/2	25	\$ 7.48
BA402-020	2	10	\$ 9.48
BA402-030	3	10	\$ 36.76
BA402-040	4	5	\$ 56.15

### REDUCING TEE SLIP X FIPT

PART NO.	SIZE "	BOX QTY.	PRICE EACH
BA402-101	3/4 x 3/4 x 1/2	50	\$ 1.68
BA402-130	1 x 1 x 1/2	50	\$ 2.57
BA402-131	1 x 1 x 3/4	50	\$ 3.65
BA402-167	1 1/4 x 1 1/4 x 3/4	25	\$ 6.07
BA402-168	1 1/4 x 1 1/4 x 1	25	\$ 6.07
BA402-209	1 1/2 x 1 1/2 x 1/2	25	\$ 7.48
BA402-210	1 1/2 x 1 1/2 x 3/4	25	\$ 7.48
BA402-211	1 1/2 x 1 1/2 x 1	25	\$ 7.48
BA402-212	1 1/2 x 1 1/2 x 1 1/4	25	\$ 7.48
BA402-247	2 x 2 x 1/2	10	\$ 9.42
BA402-248	2 x 2 x 3/4	10	\$ 9.42
BA402-249	2 x 2 x 1	10	\$ 9.42
BA402-250	2 x 2 x 1 1/4	10	\$ 9.42
BA402-251	2 x 2 x 1 1/2	10	\$ 9.42
BA402-289	2 1/2 x 2 1/2 x 1	10	\$ 20.37
BA402-291	2 1/2 x 2 1/2 x 1 1/2	10	\$ 20.37
BA402-335	3 x 3 x 1	10	\$ 29.11
BA402-337	3 x 3 x 1 1/2	10	\$ 29.11
BA402-338	3 x 3 x 2	10	\$ 29.11
BA402-420	4 x 4 x 2	5	\$ 48.62

### TEE FIPT X FIPT

PART NO.	SIZE "	BOX QTY.	PRICE EACH
BA405-005	1/2	50	\$ 3.51
BA405-007	3/4	50	\$ 5.48
BA405-010	1	50	\$ 7.06
BA405-012	1 1/4	25	\$ 10.47
BA405-015	1 1/2	25	\$ 10.82



**90° ELBOW SLIP**



PART NO.	SIZE "	BOX QTY.	PRICE EACH
BA406-005	1/2	50	\$ 0.77
BA406-007	3/4	50	\$ 0.90
BA406-010	1	50	\$ 1.58
BA406-012	1¼	25	\$ 2.73
BA406-015	1½	25	\$ 2.95
BA406-020	2	25	\$ 4.58
BA406-025	2½	10	\$ 13.92
BA406-030	3	10	\$ 16.64
BA406-040	4	5	\$ 29.75
BA406-060	6	4	\$ 94.56
BA406-080	8	3	\$ 243.50

**90° ELBOW SLIP X FIPT**



PART NO.	SIZE "	BOX QTY.	PRICE EACH
BA407-005	1/2	50	\$ 0.97
BA407-007	3/4	50	\$ 1.09
BA407-010	1	50	\$ 2.06
BA407-012	1¼	25	\$ 3.45
BA407-015	1½	25	\$ 3.81
BA407-020	2	10	\$ 9.77
BA407-211	1½ x 1	25	\$ 6.81
BA407-249	2 x 1"	25	\$ 13.10

**90° ELBOW FIPT X FIPT**



PART NO.	SIZE "	BOX QTY.	PRICE EACH
BA408-005	1/2	50	\$ 1.86
BA408-007	3/4	50	\$ 2.77
BA408-010	1	50	\$ 5.43
BA408-012	1¼	25	\$ 6.26
BA408-015	1½	25	\$ 7.92
BA408-020	2	10	\$ 11.96

**90° ELBOW STREET SLIP X SLIP**



PART NO.	SIZE "	BOX QTY.	PRICE EACH
BA409-005	1/2	50	\$ 2.15
BA409-007	3/4	50	\$ 2.67
BA409-010	1	50	\$ 4.58
BA409-015	1½	25	\$ 6.07

**90° ELBOW MIPT X SLIP**



PART NO.	SIZE "	BOX QTY.	PRICE EACH
BA410-005	1/2	50	\$ 1.67
BA410-007	3/4	50	\$ 1.97
BA410-010	1	50	\$ 3.30
BA410-012	1¼	25	\$ 4.58
BA410-015	1½	25	\$ 4.79
BA410-020	2	10	\$ 11.77

**90° ELBOW MIPT X FIPT**



PART NO.	SIZE "	BOX QTY.	PRICE EACH
BA412-005	1/2	50	\$ 2.28
BA412-007	3/4	50	\$ 2.77
BA412-010	1	50	\$ 4.69
BA412-012	1¼	25	\$ 5.82
BA412-015	1½	25	\$ 6.33
BA412-020	2	10	\$ 16.46



**22½° ELBOW SLIP X SLIP**

PART NO.	SIZE "	BOX QTY.	PRICE EACH
BA465-020	2	10	\$ 7.67
BA465-025	2½	10	\$ 19.89
BA465-030	3	5	\$ 30.84
BA465-040	4	4	\$ 55.39
BA465-060	6	3	\$ 143.92
BA465-080	8	4	\$ 585.14



**45° ELBOW SLIP**

PART NO.	SIZE "	BOX QTY.	PRICE EACH
BA417-005	1/2	50	\$ 1.28
BA417-007	3/4	50	\$ 1.97
BA417-010	1	50	\$ 2.37
BA417-012	1¼	25	\$ 3.30
BA417-015	1½	25	\$ 4.10
BA417-020	2	25	\$ 5.38
BA417-025	2½	10	\$ 13.94
BA417-030	3	10	\$ 21.63
BA417-040	4	5	\$ 38.74
BA417-060	6	4	\$ 95.71
BA417-080	8	4	\$ 230.19

**COUPLING SLIP**



PART NO.	SIZE "	BOX QTY.	PRICE EACH
BA429-005	1/2	100	\$ 0.53
BA429-007	3/4	50	\$ 0.71
BA429-010	1	50	\$ 1.21
BA429-012	1¼	25	\$ 1.68
BA429-015	1½	25	\$ 1.83
BA429-020	2	25	\$ 2.77
BA429-025	2½	10	\$ 6.07
BA429-030	3	10	\$ 9.46
BA429-040	4	5	\$ 13.68
BA429-060	6	5	\$ 43.18
BA429-080	8	4	\$ 80.58

**THREADED COUPLING**



PART NO.	SIZE "	BOX QTY.	PRICE EACH
BA430-005	1/2	100	\$ 0.99
BAG430-005	1/2 grey	100	\$ 1.03
BA430-007	3/4	50	\$ 1.83
BAG430-007	3/4 grey	50	\$ 2.02
BA430-010	1	50	\$ 2.37

**FEMALE ADAPTER FIPT X SLIP**



PART NO.	SIZE "	BOX QTY.	PRICE EACH
BA435-005	1/2	100	\$ 0.90
BA435-007	3/4	50	\$ 1.09
BA435-010	1	50	\$ 1.28
BA435-012	1¼	25	\$ 1.97
BA435-015	1½	25	\$ 2.28
BA435-020	2	25	\$ 3.01
BA435-025	2½	10	\$ 7.63
BA435-030	3	10	\$ 10.21
BA435-040	4	5	\$ 16.90
BA435-060	6	4	\$ 62.18

**REDUCING FEMALE ADAPTER FIPT X SLIP**



PART NO.	SIZE "	BOX QTY.	PRICE EACH
BA435-074	1/2 x 3/4	50	\$ 1.58
BA435-101	3/4 x 1/2	50	\$ 1.58
BA435-102	3/4 x 1	50	\$ 2.06
BA435-131	1 x 3/4	50	\$ 2.06
BA435-211	1 x 1½	25	\$ 4.10

### MALE ADAPTER MIPT X SLIP

PART NO.	SIZE "	BOX QTY.	PRICE EACH
BA436-005	1/2	100	\$ 0.71
BA436-007	3/4	50	\$ 0.77
BA436-010	1	50	\$ 1.41
BA436-012	1¼	25	\$ 1.68
BA436-015	1½	25	\$ 2.28
BA436-020	2	25	\$ 2.94
BA436-025	2½	10	\$ 8.67
BA436-030	3	10	\$ 12.64
BA436-040	4	5	\$ 16.14
BA436-060	6	4	\$ 42.05



### REDUCING MALE ADAPTER MIPT X SLIP

PART NO.	SIZE "	BOX QTY.	PRICE EACH
BA436-074	1/2 x 3/4	50	\$ 1.41
BA436-101	3/4 x 1/2	50	\$ 1.28
BA436-102	3/4 x 1	50	\$ 1.97
BA436-131	1 x 3/4	50	\$ 4.20
BA436-132	1 x 1¼	25	\$ 4.58
BA436-168	1¼ x 1	25	\$ 5.18
BA436-169	1¼ x 1½	25	\$ 5.18
BA436-212	1½ x 1¼	25	\$ 6.24
BA436-213	1½ x 2	25	\$ 6.24
BA436-251	2 x 1½	10	\$ 7.11
BA436-252	2 x 2½	10	\$ 11.07
BA436-293	2½ x 3	10	\$ 13.36
BA436-341	3 x 4	10	\$ 21.36



### REDUCING BUSHING SPIGOT X SLIP

PART NO.	SIZE "	BOX QTY.	PRICE EACH
BA437-101	3/4 x 1/2	100	\$ 0.81
BA437-130	1 x 1/2	100	\$ 1.46
BA437-131	1 x 3/4	100	\$ 1.46
BA437-167	1¼ x 3/4	25	\$ 1.97
BA437-168	1¼ x 1	25	\$ 1.97
BA437-209	1½ x 1/2	25	\$ 2.09
BA437-210	1½ x 3/4	25	\$ 2.09
BA437-211	1½ x 1	25	\$ 2.09
BA437-212	1½ x 1¼	25	\$ 2.09
BA437-248	2 x 3/4	10	\$ 3.45
BA437-249	2 x 1	10	\$ 3.45
BA437-250	2 x 1¼	10	\$ 3.45
BA437-251	2 x 1½	25	\$ 3.45
BA437-289	2½ x 1	10	\$ 5.50
BA437-290	2½ x 1¼	10	\$ 5.50
BA437-291	2½ x 1½	10	\$ 5.50
BA437-292	2½ x 2	10	\$ 5.50
BA437-335	3 x 1	10	\$ 8.11
BA437-337	3 x 1½	10	\$ 8.11
BA437-338	3 x 2	10	\$ 8.11
BA437-339	3 x 2½	10	\$ 8.11
BA437-420	4 x 2	5	\$ 18.05
BA437-421	4 x 2½	5	\$ 18.05
BA437-422	4 x 3	5	\$ 18.05
BA437-530	6 x 3	5	\$ 44.70
BA437-532	6 x 4	5	\$ 44.70
BA437-582	8 x 4	5	\$ 155.87
BA437-585	8 x 6	5	\$ 155.87



### REDUCING BUSHING SPIGOT X FIPT

PART NO.	SIZE "	BOX QTY.	PRICE EACH
BA438-098	3/4 x 1/4	50	\$ 1.68
BA438-101	3/4 x 1/2	100	\$ 1.28
BA438-130	1 x 1/2	100	\$ 2.06
BA438-131	1 x 3/4	100	\$ 2.06
BA438-166	1¼ x 1/2	25	\$ 3.14
BA438-167	1¼ x 3/4	25	\$ 3.14
BA438-168	1¼ x 1	25	\$ 3.14
BA438-209	1½ x 1/2	25	\$ 3.65
BA438-210	1½ x 3/4	25	\$ 3.65
BA438-211	1½ x 1	25	\$ 3.65
BA438-212	1½ x 1¼	25	\$ 3.65
BA438-247	2 x 1/2	10	\$ 4.85
BA438-248	2 x 3/4	10	\$ 4.85
BA438-249	2 x 1	10	\$ 4.85
BA438-250	2 x 1¼	10	\$ 4.85
BA438-251	2 x 1½	10	\$ 4.85
BA438-289	2½ x 1	10	\$ 7.05
BA438-291	2½ x 1½	10	\$ 7.05
BA438-292	2½ x 2	10	\$ 7.05
BA438-335	3 x 1	10	\$ 8.11
BA438-337	3 x 1½	10	\$ 8.11
BA438-338	3 x 2	10	\$ 8.11
BA438-339	3 x 2½	10	\$ 8.11
BA438-420	4 x 2	5	\$ 18.02
BA438-422	4 x 3	5	\$ 18.02
BA438-532	6 x 4	5	\$ 65.96



### THREADED REDUCING BUSHING MIPT X FIPT

PART NO.	SIZE "	BOX QTY.	PRICE EACH
BA439-072	1/2 x 1/4	50	\$ 3.65
BA439-073	1/2 x 3/8	50	\$ 3.65
BA439-098	3/4 x 1/4	50	\$ 2.28
BA439-101	3/4 x 1/2	50	\$ 2.28
BA439-130	1 x 1/2	50	\$ 3.14
BA439-131	1 x 3/4	50	\$ 3.14
BA439-167	1¼ x 3/4	25	\$ 4.67
BA439-168	1¼ x 1	25	\$ 4.67
BA439-209	1½ x 1/2	25	\$ 5.65
BA439-210	1½ x 3/4	25	\$ 5.65
BA439-211	1½ x 1	25	\$ 5.65
BA439-212	1½ x 1¼	25	\$ 5.65
BA439-249	2 x 1	10	\$ 6.07
BA439-250	2 x 1¼	10	\$ 6.07
BA439-251	2 x 1½	10	\$ 6.07
BA439-292	2½ x 2	10	\$ 21.10
BA439-338	3 x 2	5	\$ 24.93



### CAP SLIP

PART NO.	SIZE "	BOX QTY.	PRICE EACH
BA447-005	1/2	100	\$ 0.71
BA447-007	3/4	100	\$ 0.81
BA447-010	1	50	\$ 1.28
BA447-012	1¼	25	\$ 1.83
BA447-015	1½	25	\$ 1.97
BA447-020	2	25	\$ 2.37
BA447-025	2½	10	\$ 7.48
BA447-030	3	10	\$ 8.16
BA447-040	4	5	\$ 18.59
BA447-060	6	5	\$ 44.55
BA447-080	8	5	\$ 111.86





# Schedule 80 Fittings

**LASCO**  
Fittings, Inc.

www.lascofittings.com

## CAP THREADED FIPT



PART NO.	SIZE "	BOX QTY.	PRICE EACH
BA448-005	1/2	100	\$ 1.46
BA448-007	3/4	100	\$ 1.68
BA448-010	1	50	\$ 2.57
BA448-012	1¼	25	\$ 3.01
BA448-015	1½	25	\$ 3.14
BA448-020	2	10	\$ 5.55
BA448-025	2½	10	\$ 8.16
BA448-030	3	10	\$ 10.70
BA448-040	4	5	\$ 18.75

## PLUG SPIGOT



PART NO.	SIZE "	BOX QTY.	PRICE EACH
BA449-005	1/2	50	\$ 1.68
BA449-007	3/4	50	\$ 1.97
BA449-015	1½	25	\$ 4.01
BA449-020	2	10	\$ 4.98
BA449-030	3	10	\$ 11.16

## PLUG MIPT



PART NO.	SIZE "	BOX QTY.	PRICE EACH
BA450-005	1/2	50	\$ 2.09
BA450-007	3/4	50	\$ 2.22
BA450-010	1	50	\$ 3.65
BA450-012	1¼	25	\$ 3.83
BA450-015	1½	25	\$ 4.07
BA450-020	2	10	\$ 5.27
BA450-025	2½	10	\$ 7.34
BA450-030	3	10	\$ 11.06
BA450-040	4	5	\$ 25.01

## Surge Guard Fittings

### SURGE GUARD FITTINGS



PART NO.	SIZE "	BOX QTY.	PRICE EACH
BA301-020	2" Tee	25	\$ 20.74
BA301-025	2½" Tee	10	\$ 43.43
BA306-020	2" 90 Elbow	10	\$ 12.46
BA306-025	2½" 90 Elbow	10	\$ 35.13
BA317-020	2" 45 Elbow	10	\$ 13.89
BA317-025	2½" 45 Elbow	10	\$ 21.93

## Schedule 80 Fittings

### TEE SLIP x SLIP



PART NO.	SIZE "	BOX QTY.	PRICE EACH
BA801-030	3	5	\$ 63.29

### 90 ° ELBOW SLIP x SLIP



PART NO.	SIZE "	BOX QTY.	PRICE EACH
BA806-030	3	5	\$ 38.99

### 22½° ELBOW SLIP x SLIP



PART NO.	SIZE "	BOX QTY.	PRICE EACH
BA865-020	2	10	\$ 36.29
BA865-025	2½	10	\$ 47.98
BA865-030	3	10	\$ 75.00

### 45 ° ELBOW SLIP x SLIP



PART NO.	SIZE "	BOX QTY.	PRICE EACH
BA817-030	3	5	\$ 78.91

### SLIP COUPLING



PART NO.	SIZE "	BOX QTY.	PRICE EACH
BA829-020	2	10	\$ 18.45
BA829-025	2½	5	\$ 40.05
BA829-030	3	5	\$ 46.02

### THREADED COUPLING



PART NO.	SIZE "	BOX QTY.	PRICE EACH
BA830-020	2	10	\$ 41.01

### FIPT X SLIP ADAPTER



PART NO.	SIZE "	BOX QTY.	PRICE EACH
BA835-015	1½	10	\$ 36.59
BA835-020	2	10	\$ 47.14

### MIPT X SLIP ADAPTER



PART NO.	SIZE "	BOX QTY.	PRICE EACH
BA836-020	2	10	\$ 35.96
BA836-025	2½	5	\$ 40.88
BA836-030	3	5	\$ 45.37
BA836-213	1½ x 2	10	\$ 27.51
BA836-251	2 x 1½	10	\$ 31.99

### REDUCING BUSHING SLIP x SLIP



PART NO.	SIZE "	BOX QTY.	PRICE EACH
BA837-249	2 x 1	10	\$ 18.65
BA837-250	2 x 1¼	10	\$ 23.16
BA837-292	2½ x 2	5	\$ 32.39
BA837-338	3 x 2	5	\$ 51.38
BA837-339	3 x 2½	5	\$ 45.90
BA837-420	4 x 2	5	\$ 50.19
BA837-422	4 x 3	5	\$ 87.96

### REDUCING BUSHING SLIP x THREAD



PART NO.	SIZE "	BOX QTY.	PRICE EACH
BA838-249	2 x 1	10	\$ 19.05
BA838-251	2 x 1½	10	\$ 19.05
BA838-289	2½ x 1	5	\$ 50.62
BA838-335	3 x 1	5	\$ 93.72

## LASCO<sup>®</sup> Fittings, Inc.

www.lascofittings.com

### REDUCING BUSHING THREADED SCHEDULE 80



PART NO.	SIZE "	BOX QTY.	PRICE EACH
BA839-211	1½ x 1	10	\$ 21.90
BA839-249	2 x 1	10	\$ 23.68
BA839-251	2 x 1½	10	\$ 23.66

### SOLID SLIP FLANGE SCHEDULE 80



PART NO.	SIZE "	BOX QTY.	PRICE EACH
BA851-020	2	10	\$ 33.49
BA851-030	3	10	\$ 57.09
BA851-040	4	5	\$ 72.30
BA851-060	6	5	\$ 113.67

### SOLID THREADED FLANGE SCHEDULE 80



PART NO.	SIZE "	BOX QTY.	PRICE EACH
BA852-015	1½	10	\$ 46.42
BA852-030	3	5	\$ 112.33
BA852-040	4	5	\$ 211.06

### LOOSE RING SLIP FLANGE SCHEDULE 80



PART NO.	SIZE "	BOX QTY.	PRICE EACH
BA854-020	2	5	\$ 45.31
BA854-030	3	5	\$ 57.07
BA854-040	4	5	\$ 72.17
BA854-060	6	5	\$ 113.57
BA854-080	8	5	\$ 184.91

### SLIP UNION SCHEDULE 80



PART NO.	SIZE "	BOX QTY.	PRICE EACH
BA897-010	1	10	\$ 26.72
BA897-012	1¼	5	\$ 39.19
BA897-015	1½	5	\$ 44.36
BA897-020	2	5	\$ 68.15
BA897-030	3	5	\$ 153.64

### THREADED UNION SCHEDULE 80



PART NO.	SIZE "	BOX QTY.	PRICE EACH
BA898-005	1/2	10	\$ 15.78
BA898-007	3/4	10	\$ 29.95
BA898-010	1	10	\$ 33.30
BA898-015	1½	5	\$ 69.43
BA898-020	2	5	\$ 106.80
BA898-030	3	5	\$ 270.93

### FLANGE GASKETS

PART #	DESCRIPTION	PRICE
GAPVBFG2	2" flange gasket, red rubber	\$ 4.60
GAPVBFG25	2½" flange gasket, red rubber	\$ 2.55
GAPVBFG3	3" flange gasket, red rubber	\$ 6.39
GAPVBFG4	4" flange gasket, red rubber	\$ 7.42
GAPVBFG6	6" flange gasket, red rubber	\$ 9.74
GAPVBFG8	8" flange gasket, red rubber	\$ 11.58

### FLANGE BOLT KITS

PART #	DESCRIPTION	PRICE
GAPVBK3350	Bolt kit for 2-3" flange, 4 bolts	\$ 11.58
GAPVBK4450	Bolt kit for 4" flange, 8 bolts	\$ 28.85
GAPVBK568500	Bolt kit for 6" flange, 8 bolts	\$ 36.00



## Online Training Portal

- ☀ Irrigation Association Certified
- ☀ Water Smart Irrigation Professional Certified
- ☀ On-Board new or season employees
- ☀ Learn potential new services like Landscape Lighting or Drainage





## PVC PRESSURE REPAIR COUPLING

*Make PVC Pipe Repairs Easy!*



The HARCO "Knock On" repair coupling is the best repair coupling available in the market today. The unique gasket design allows for travel in both directions, making it easy to slide the coupling back onto the existing pipe from the repair section.

The square face bell design allows for a larger object, such as a wood block, to be placed against the fitting in order to knock the repair coupling into place. All HARCO repair couplings are pressure rated to 200 psi and, with no bolts, there is nothing to tighten to engage the gasket. With no glue and no set time required, the repair coupling is completed as soon as you install it. Water pressure can be turned back on immediately, allowing you to resume operations as normal.

The combination of all these features make the HARCO "Knock-On" repair coupling the simplest and quickest repair coupling available in the market today!

### Installation Instructions:

1. Cut out and remove damaged section of pipe as required.
2. Cut and bevel new pipe to fit the gap of the repair section, accounting for the overhang of the gasket race of the repair coupling as shown.
3. Using generous amounts of pipe lube, install repair couplings on pipe section as shown.
4. Bevel ends of pipe in ground. Apply pipe lube to pipe ends and coupling gaskets.
5. Mark pipe to use as guide to center coupling over joint.
6. Align and slide repair couplings over the original pipe to mark centering the couplings over the cut.

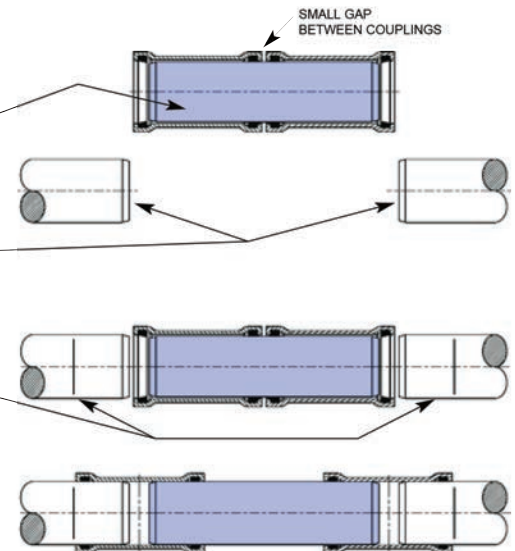

#### NOTES:

- Gap between ends of pipe will have no effect on system performance.
- In systems using mechanical joint restraint or glue joint fittings, care must be taken with repairs in the restrained lengths to see that proper thrust restraint is maintained.



## Repair Couplings

SLIP FIX REPAIR COUPLINGS		CASE QTY.	PRICE
BACUF010	1"	25	\$ 11.40
BACUF015	1½"	15	\$ 23.00
BACUF020	2"	8	\$ 35.78
BACUF025	2½"	8	\$ 57.52
BACUF030	3"	3	\$ 72.00
BACUF040	4"	2	\$ 125.87
BACUF060	6"	1	\$ 343.69

COMPRESSION COUPLINGS		CASE QTY.	PRICE
BA0110-10	1"	10	\$ 22.97
BA0110-15	1½"	10	\$ 35.74
BA0110-20	2"	10	\$ 47.33
BA0110-25	2½"	8	\$ 88.23
BA0110-30	3"	5	\$ 115.27
BA0110-40	4"	6	\$ 189.80
BA0110-60	6"	4	\$ 348.68

HARCO REPAIR COUPLERS		CASE QTY.	PRICE
MD109-015	1½"	24	\$ 62.12
MD109-020	2"	24	\$ 68.14
MD109-025	2½"	24	\$ 74.93
MD109-030	3"	24	\$ 168.62
MD109-040	4"	12	\$ 168.62
MD109-060	6"	6	\$ 296.40
MD109-080	8"	4	\$ 610.53
MD109-100	10"	1	\$ 1,130.63

# Performance. Redefined.



## Advance with R-VAN Rotary Nozzles.

Rotary nozzles have evolved. Don't settle for dated technology and underperformance. The Rain Bird® R-VAN line features modern engineering that produces more efficient coverage while streamlining installation. The future of rotary nozzles is here. Are you ready to advance with R-VAN?

Learn more at [rvanrotarynozzles.rainbird.com](http://rvanrotarynozzles.rainbird.com).



**RAIN**  **BIRD**®





## 1800 Series Spray Heads

Superior components and first rate design features make this the spray head of choice for a variety of applications.

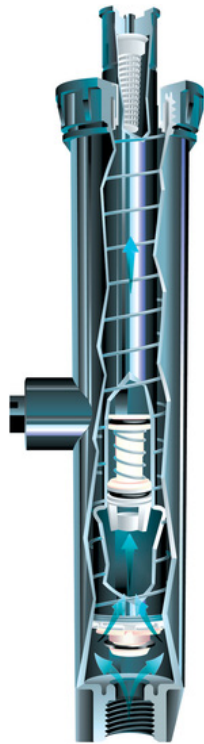

STANDARD MODEL		CASE QTY.	EACH
AX1802R	2"	100	\$ 8.63
AX1804R	4"	75	\$ 4.28
AX1806R	6"	50	\$ 19.71
AX1812R	12"	50	\$ 26.00

### PRS - PRESSURE REGULATING STEM

AX1804PRS	4" 30PSI	75	\$ 15.09
AX1806PRS	6" 30PSI	50	\$ 37.04
AX1812PRS	12" 30PSI	50	\$ 43.42
AX1804SAMPRS45	4" PRS 45 PSI with S.A.M.	75	\$ 21.54
AX1806SAMPRS45	6" PRS 45 PSI with S.A.M.	50	\$ 49.37
AX1812SAMPRS45	12 PRS 45 PSI with S.A.M.	50	\$ 60.42

### S.A.M. - SEAL-A-MATIC CHECK VALVE

AX1804SAM	4" SAM	75	\$ 11.29
AX1806SAM	6" SAM	50	\$ 30.73
AX1812SAM	12" SAM	50	\$ 40.46

### S.A.M. - PRS

AX1804SAMPRS	4" SAMPRS 30 PSI	75	\$ 18.61
AX1806SAMPRS	6" SAMPRS 30 PSI	50	\$ 49.37
AX1812SAMPRS	12" SAMPRS 30 PSI	50	\$ 60.42



### 1800 ACCESSORIES

AX1800PA8S	Shrub Adapter	50	\$ 2.86
AX1800EXT	6" Stem Extension	50	\$ 9.77
AX1800NP	Non-Potable Cap	N/A	\$ 8.36

### NOZZLES

		BAG QTY.	EACH
MPR & VAN SERIES	See Nozzle Chart for Part Number	25	\$ 2.85
HE-VAN SERIES	See Nozzle Chart for Part Number	25	\$ 2.78
U-SERIES	See Nozzle Chart for Part Number	25	\$ 5.42



## High-Efficiency Spray Nozzles



### U-SERIES NOZZLES

ARC	PRESSURE PSI	U8 GREEN 10° TRAJECTORY			U10 BLUE 12° TRAJECTORY			U12 BROWN 23° TRAJECTORY			U15 BLACK 23° TRAJECTORY		
		RADIUS ft.	FLOW GPM	PRECIP IN/H	RADIUS ft.	FLOW GPM	PRECIP IN/H	RADIUS ft.	FLOW GPM	PRECIP IN/H	RADIUS ft.	FLOW GPM	PRECIP IN/H
FULL	15	5	0.74	2.39	7	1.16	2.39	9	1.80	2.47	11	2.60	2.39
	20	6	0.86	2.32	8	1.34	2.32	10	2.10	2.34	12	3.00	2.32
	25	7	0.96	1.87	9	1.50	1.87	11	2.40	2.21	14	3.30	1.87
HALF	15	5	0.37	2.39	7	0.58	2.39	9	0.90	2.47	11	1.30	2.39
	20	6	0.42	2.32	8	0.67	2.32	10	1.05	2.34	12	1.50	2.32
	25	7	0.47	1.87	9	0.75	1.87	11	1.20	2.21	14	1.65	1.87
QUARTER	15	5	0.52	1.83	10	0.82	1.83	12	1.30	2.01	15	1.85	1.83
	20	6	0.18	2.39	7	0.29	2.39	9	0.45	2.47	11	0.65	2.39
	25	7	0.21	2.32	8	0.33	2.32	10	0.53	2.34	12	0.75	2.32
	30	8	0.24	1.87	9	0.37	1.87	11	0.60	2.21	14	0.82	1.87
	30	8	0.26	1.83	10	0.41	1.83	12	0.65	2.01	15	0.92	1.83

### HE-VAN SERIES NOZZLES

ARC	PRESSURE PSI	8 HE-VAN GREEN 24° TRAJECTORY			10 HE-VAN BLUE 21° TRAJECTORY			12 HE-VAN BROWN 23° TRAJECTORY			15 HE-VAN BLACK 25° TRAJECTORY		
		RADIUS ft.	FLOW GPM	PRECIP IN/H	RADIUS ft.	FLOW GPM	PRECIP IN/H	RADIUS ft.	FLOW GPM	PRECIP IN/H	RADIUS ft.	FLOW GPM	PRECIP IN/H
FULL	15	5	0.83	3.68	7	1.26	2.86	9	1.67	2.40	11	2.62	2.40
	20	6	0.96	2.95	8	1.46	2.53	10	1.93	2.33	12	3.02	2.33
	25	7	1.07	2.42	9	1.63	2.24	11	2.16	1.92	14	3.38	1.92
3/4	15	5	0.62	3.68	7	0.95	2.86	9	1.25	2.40	11	1.96	2.40
	20	6	0.72	2.95	8	1.09	2.53	10	1.45	2.33	12	2.27	2.33
	25	7	0.80	2.42	9	1.22	2.24	11	1.62	1.92	14	2.53	1.92
HALF	15	5	0.41	3.68	7	0.63	2.86	9	0.84	2.40	11	1.31	2.40
	20	6	0.48	2.95	8	0.73	2.53	10	0.97	2.33	12	1.51	2.33
	25	7	0.53	2.42	9	0.81	2.24	11	1.08	1.92	14	1.69	1.92
QUARTER	15	5	0.59	2.03	10	0.89	1.98	12	1.18	1.83	15	1.85	1.83
	20	6	0.21	3.68	7	0.32	2.86	9	0.42	2.40	11	0.65	2.40
	25	7	0.24	2.95	8	0.36	2.53	10	0.47	2.33	12	0.76	2.33
	30	8	0.27	2.42	9	0.41	2.24	11	0.54	1.92	14	0.84	1.92
	30	8	0.29	2.03	10	0.45	1.98	12	0.59	1.83	15	0.93	1.83



### STRIP SERIES

ARC	PRESSURE PSI	15EST			15CST			15RCS			15LCS			15SST			9SST		
		WIDTH	LENGTH	FLOW GPM	WIDTH	LENGTH	FLOW GPM	WIDTH	LENGTH	FLOW GPM	WIDTH	LENGTH	FLOW GPM	WIDTH	LENGTH	FLOW GPM	WIDTH	LENGTH	FLOW GPM
15	4	13	0.45	4	26	0.89	3	11	0.35	3	11	0.35	4	26	0.89	9	15	1.34	
20	4	14	0.50	4	28	1.00	3	12	0.40	3	12	0.40	4	28	1.00	9	16	1.47	
25	4	14	0.56	4	28	1.11	4	14	0.45	4	14	0.45	4	28	1.11	9	18	1.60	
30	4	15	0.61	4	30	1.21	4	15	0.49	4	15	0.49	4	30	1.21	9	18	1.73	



### MPR SERIES NOZZLES

ARC	PRESSURE PSI	5 RED 5° TRAJECTORY				8 GREEN 10° TRAJECTORY				10 BLUE 15° TRAJECTORY				12 BROWN 30° TRAJECTORY				15 BLACK 30° TRAJECTORY			
		RADIUS ft.	FLOW GPM	PRECIP IN/H	PRECIP IN/H	RADIUS ft.	FLOW GPM	PRECIP IN/H	PRECIP IN/H	RADIUS ft.	FLOW GPM	PRECIP IN/H	PRECIP IN/H	RADIUS ft.	FLOW GPM	PRECIP IN/H	PRECIP IN/H	RADIUS ft.	FLOW GPM	PRECIP IN/H	PRECIP IN/H
F	15	3	0.29	2.07	2.39	5	0.74	2.07	2.39	7	1.16	2.28	2.63	9	1.80	2.14	2.47	11	2.60	2.07	2.39
	20	4	0.33	2.01	2.32	6	0.86	2.01	2.32	8	1.30	1.96	2.26	10	2.10	2.02	2.34	12	3.00	2.01	2.32
	25	4	0.37	1.62	1.87	7	0.96	1.62	1.87	9	1.44	1.71	1.98	11	2.40	1.91	2.21	14	3.30	1.62	1.87
	30	5	0.41	1.58	1.83	8	1.05	1.58	1.83	10	1.58	1.52	1.75	12	2.60	1.74	2.01	15	3.70	1.58	1.83
H	15	3	0.14	2.07	2.39	5	0.37	2.07	2.39	7	0.58	2.28	2.63	9	0.90	2.14	2.47	11	1.30	2.07	2.39
	20	4	0.16	2.01	2.32	6	0.42	2.01	2.32	8	0.65	1.96	2.26	10	1.05	2.02	2.34	12	1.50	2.01	2.32
	25	4	0.18	1.62	1.87	7	0.47	1.62	1.87	9	0.72	1.71	1.98	11	1.20	1.91	2.21	14	1.65	1.62	1.87
	30	5	0.20	1.58	1.83	8	0.52	1.58	1.83	10	0.79	1.52	1.75	12	1.30	1.74	2.01	15	1.85	1.58	1.83
Q	15	3	0.07	2.07	2.39	5	0.18	2.07	2.39	7	0.29	2.28	2.63	9	0.45	2.14	2.47	11	0.65	2.07	2.39
	20	4	0.08	2.01	2.32	6	0.21	2.01	2.32	8	0.33	1.96	2.26	10	0.53	2.02	2.34	12	0.75	2.01	2.32
	25	4	0.09	1.62	1.87	7	0.24	1.62	1.87	9	0.36	1.71	1.98	11	0.60	1.91	2.21	14	0.82	1.62	1.87
	30	5	0.10	1.58	1.83	8	0.26	1.58	1.83	10	0.39	1.52	1.75	12	0.65	1.74	2.01	15	0.92	1.58	1.83



## VAN Series Nozzles

### VAN SERIES NOZZLES

ARC	PRESSURE PSI	4 VAN YELLOW 0° TRAJECTORY				6 VAN ORANGE 0° TRAJECTORY				8 VAN GREEN 5° TRAJECTORY				10 VAN BLUE 10° TRAJECTORY				12 VAN BROWN 15° TRAJECTORY				15 VAN BLACK 23° TRAJECTORY				18 VAN BEIGE 26° TRAJECTORY			
		RADIUS ft.	FLOW GPM	PRECIP IN/H	PRECIP IN/H	RADIUS ft.	FLOW GPM	PRECIP IN/H	PRECIP IN/H	RADIUS ft.	FLOW GPM	PRECIP IN/H	PRECIP IN/H	RADIUS ft.	FLOW GPM	PRECIP IN/H	PRECIP IN/H	RADIUS ft.	FLOW GPM	PRECIP IN/H	PRECIP IN/H	RADIUS ft.	FLOW GPM	PRECIP IN/H	PRECIP IN/H				
360°	15	3	0.62	7.23	8.35	4	0.85	5.58	6.44	6	1.21	3.53	4.07	7	1.963	3.80	4.93	9	1.56	1.86	2.14	11	2.60	2.07	2.39	14	4.21	2.07	2.39
	20	3	0.70	8.17	9.43	5	0.96	4.03	4.65	7	1.36	2.91	3.36	8	2.32	3.50	4.04	10	1.86	1.79	2.06	12	3.00	2.01	2.32	15	4.70	2.01	2.32
	25	4	0.80	5.25	6.06	5	1.09	4.58	5.29	7	1.55	3.32	3.83	9	2.52	3.00	3.46	11	2.12	1.68	1.95	14	3.30	1.62	1.87	17	4.86	1.62	1.87
	30	4	0.88	5.78	6.67	6	1.20	3.50	4.04	8	1.70	2.79	3.22	10	2.60	2.50	2.89	12	2.36	1.58	1.82	15	3.70	1.58	1.83	18	5.32	1.58	1.83
270°	15	3	0.52	7.42	8.57	4	0.79	6.34	7.32	6	1.11	3.95	4.55	7	1.45	3.80	4.39	9	1.17	1.86	2.14	11	1.95	2.07	2.39	14	3.16	2.07	2.39
	20	3	0.58	8.27	9.55	5	0.88	4.52	5.22	7	1.24	3.24	3.74	8	1.75	3.50	4.04	10	1.39	1.79	2.06	12	2.25	2.01	2.32	15	3.52	2.01	2.32
	25	4	0.66	5.29	6.11	5	1.00	5.13	5.92	7	1.41	3.69	4.25	9	1.89	3.00	3.46	11	1.59	1.68	1.94	14	2.48	1.62	1.87	17	3.65	1.62	1.87
	30	4	0.73	5.86	6.77	6	1.10	3.92	4.53	8	1.55	3.10	3.58	10	2.10	2.70	3.12	12	1.77	1.58	1.82	15	2.78	1.58	1.83	18	3.99	1.58	1.83
180°	15	3	0.32	6.84	7.90	4	0.42	5.05	5.83	6	0.84	4.49	5.18	7	0.97	3.80	4.39	9	0.78	1.86	2.14	11	1.30	2.07	2.39	14	2.11	2.07	2.39
	20	3	0.37	7.91	9.13	5	0.49	3.77	4.35	7	0.97	3.81	4.40	8	1.20	3.50	4.04	10	0.93	1.79	2.06	12	1.50	2.01	2.32	15	2.35	2.01	2.32
	25	4	0.41	4.93	5.69	5	0.55	4.24	4.90	7	1.09	4.28	4.94	9	1.26	3.00	3.46	11	1.06	1.68	1.95	14	1.65	1.62	1.87	17	2.43	1.62	1.87
	30	4	0.45	5.41	6.25	6	0.60	3.21	3.71	8	1.19	3.58	4.13	10	1.45	2.80	3.23	12	1.18	1.58	1.82	15	1.85	1.58	1.83	18	2.66	1.58	1.83
90°	15	3	0.21	8.98	10.37	4	0.26	6.26	7.23	6	0.51	5.46	6.29	7	0.48	3.80	4.39	9	0.39	1.86	2.14	11	0.65	2.07	2.39	14	1.05	2.07	2.39
	20	3	0.24	10.27	11.86	5	0.30	4.62	5.33	7	0.59	4.64	5.35	8	0.58	3.50	4.04	10	0.46	1.79	2.06	12	0.75	2.01	2.32	15	1.17	2.01	2.32
	25	4	0.26	6.26	7.23	5	0.34	5.24	6.05	7	0.66	5.19	5.98	9	0.63	3.00	3.46	11	0.53	1.68	1.95	14	0.82	1.62	1.87	17	1.22	1.62	1.87
	30	4	0.29	6.98	8.06	6	0.37	3.96	4.57	8	0.72	4.33	5.00	10	0.75	2.90	3.35	12	0.59	1.58	1.82	15	0.92	1.58	1.83	18	1.33	1.58	1.83





www.rainbird.com

## Rotary Nozzles

Rain Bird® R-VAN Adjustable Rotary Nozzles provide water efficiency and design flexibility. R-VAN Adjustable Rotary Nozzles feature rotating stream technology which uniformly delivers water at a low precipitation rate, significantly reducing runoff and erosion. Use an R-VAN nozzle on 1800 series PRS45 spray bodies for maximum efficiency.

**Benefits:**

- Maintains efficient performance at high operating pressures without misting or fogging
- Compatible with all models of Rain Bird spray bodies in addition to a wide variety of risers and adapters
- Matched precipitation rates across radius and arcs simplify the design process



ROTARY NOZZLE SERIES		COLOUR	BAG QTY.	EACH
AXRVAN14	45° - 270° Adjustable Arc, 8' - 14'	Blue	10	\$ 14.55
AXRVAN14-360	Full Circle, 8' - 14'	Blue	10	\$ 14.55
AXRVAN18	45° - 270° Adjustable Arc, 13' - 18'	Beige	10	\$ 14.55
AXRVAN18-360	Full Circle, 13' - 18'	Beige	10	\$ 14.55
AXRVAN24	45° - 270° Adjustable Arc, 17' - 24'	Burgundy	10	\$ 14.55
AXRVAN24-360	Full Circle, 17' - 24'	Burgundy	10	\$ 14.55
AXRVANLCS	Left Corner Strip, 5' x 15'	Light Grey	10	\$ 14.55
AXRVANRCS	Side Strip, 5' x 30'	Grey	10	\$ 14.55
AXRVANSST	Right Corner Strip, 5' x 15'	Black	10	\$ 14.55

**RVAN14- BLUE**

ARC	PRESSURE PSI	RADIUS	FLOW GPM	PRECIP IN/HR	PRECIP IN/HR
	30	13	0.84	0.64	0.76
	35	13	0.87	0.66	0.74
	40	14	0.92	0.60	0.71
	45	14	0.94	0.62	0.70
	50	15	1.11	0.63	0.73
	55	15	1.17	0.67	0.77
	30	13	0.56	0.64	0.76
	35	13	0.58	0.66	0.74
	40	14	0.61	0.6	0.71
	45	14	0.63	0.62	0.70
	50	15	0.74	0.63	0.73
	55	15	0.78	0.67	0.77
	30	13	0.28	0.64	0.74
	35	13	0.29	0.66	0.76
	40	14	0.31	0.61	0.70
	45	14	0.32	0.63	0.73
	50	15	0.37	0.63	0.73
	55	15	0.39	0.67	0.77

**RVAN18- BEIGE**

ARC	PRESSURE PSI	RADIUS	FLOW GPM	PRECIP IN/HR	PRECIP IN/HR
	30	16	1.26	0.65	0.75
	35	16	1.35	0.64	0.74
	40	17	1.42	0.63	0.73
	45	18	1.51	0.60	0.69
	50	18	1.57	0.60	0.69
	55	18	1.62	0.60	0.69
	30	16	0.85	0.65	0.75
	35	16	0.91	0.64	0.74
	40	17	0.98	0.63	0.73
	45	18	1.01	0.60	0.69
	50	18	1.07	0.60	0.69
	55	18	1.09	0.60	0.69
	30	16	0.42	0.65	0.75
	35	16	0.47	0.64	0.74
	40	17	0.50	0.63	0.73
	45	18	0.50	0.60	0.69
	50	18	0.54	0.60	0.69
	55	18	0.58	0.60	0.69

**RVAN24- BURGUNDY**

ARC	PRESSURE PSI	RADIUS	FLOW GPM	PRECIP IN/HR	PRECIP IN/HR
	30	21	2.26	0.70	0.81
	35	22	2.39	0.66	0.76
	40	23	2.55	0.63	0.73
	45	23	2.73	0.61	0.70
	50	24	2.76	0.61	0.70
	55	24	2.80	0.61	0.70
	30	21	1.41	0.70	0.81
	35	22	1.55	0.66	0.76
	40	23	1.69	0.63	0.73
	45	23	1.83	0.61	0.70
	50	24	1.91	0.61	0.70
	55	24	1.98	0.61	0.70
	30	21	0.73	0.70	0.81
	35	22	0.78	0.66	0.76
	40	23	0.85	0.63	0.73
	45	23	0.91	0.61	0.70
	50	24	0.98	0.61	0.70
	55	24	1.05	0.61	0.70

**RVAN14-360- BLUE**

ARC	PRESSURE PSI	RADIUS	FLOW GPM	PRECIP IN/HR	PRECIP IN/HR
	30	13	1.10	0.63	0.72
	35	13	1.12	0.64	0.74
	40	14	1.22	0.60	0.69
	45	14	1.27	0.62	0.72
	50	15	1.41	0.60	0.70
	55	15	1.45	0.62	0.72

**RVAN18-360- BEIGE**

ARC	PRESSURE PSI	RADIUS	FLOW GPM	PRECIP IN/HR	PRECIP IN/HR
	30	16	1.65	0.62	0.72
	35	16	1.67	0.63	0.73
	40	17	1.80	0.60	0.69
	45	17	1.85	0.62	0.71
	50	18	2.05	0.61	0.70
	55	18	2.11	0.63	0.72

**RVAN24-360- BURGUNDY**

ARC	PRESSURE PSI	RADIUS	FLOW GPM	PRECIP IN/HR	PRECIP IN/HR
	30	19	2.35	0.63	0.72
	35	20	2.52	0.61	0.70
	40	22	3.13	0.62	0.72
	45	23	3.48	0.63	0.73
	50	24	3.61	0.60	0.70
	55	24	3.74	0.62	0.72

**RVANLCS- LIGHT GREY**

ARC	PRESSURE PSI	RADIUS	FLOW GPM	PRECIP IN/HR	PRECIP IN/HR
	30	4x14	0.18	0.62	0.62
	35	5x15	0.22	0.56	0.56
	40	5x15	0.23	0.59	0.59
	45	5x15	0.24	0.62	0.62
	50	5x15	0.25	0.64	0.64
	55	6x16	0.28	0.56	0.56

**RVANSST- BLACK**

ARC	PRESSURE PSI	RADIUS	FLOW GPM	PRECIP IN/HR	PRECIP IN/HR
	30	4x28	0.36	0.62	0.62
	35	5x30	0.44	0.56	0.56
	40	5x30	0.46	0.59	0.59
	45	5x30	0.48	0.62	0.62
	50	5x30	0.50	0.64	0.64
	55	6x32	0.56	0.56	0.56

**RVANRCS- GREY**

ARC	PRESSURE PSI	RADIUS	FLOW GPM	PRECIP IN/HR	PRECIP IN/HR
	30	4x14	0.18	0.62	0.62
	35	5x15	0.22	0.56	0.56
	40	5x15	0.23	0.59	0.59
	45	5x15	0.24	0.62	0.62
	50	5x15	0.25	0.64	0.64
	55	6x16	0.28	0.56	0.56



5000 SERIES • 3/4" FIPT

## 5000 Series Rotor

Rugged mid-range 3/4" inlet gear-driven rotor sprinkler, offering durability, performance and top adjustment convenience for residential and commercial sites with spacing up to 50 feet.

### Features:

- PLUS: Flow shutoff
- Top-adjust arc adjustment requiring only a flat-bladed screwdriver
- 40°-360° Arc Rotation and reversing Full-Circle rotation in one
- Quick Check Arc/Fast Forward
- Nozzle tree included
- Slip Clutch: Quickly set the left edge of the 5000 Series rotor
- Available with 2.0 or 3.0 Rain-Curtain™ nozzles pre-installed
- 5004PC and 5004PC-2.0 have SAM screens installed
- MPR Nozzles available upon request



5000 SERIES ROTOR		CASE QTY.	EACH
AX5004PC	Part Circle, No SAM	20	\$ 27.04
AX5004PCSAM	Part Circle	20	\$ 34.32
AX5004PCSAM20	Part Circle c/w 2.0 nozzle	20	\$ 34.32
AXP170452	Sam Screen	100	\$ 12.23
AX5004PCR	Part circle pressure regulated (No S.A.M)	20	\$ 46.80

### STANDARD ANGLE NOZZLE SET - 5000/5000 PLUS

PRESSURE PSI	NOZZLE	RADIUS FT.	FLOW GPM	PRECIP IN/HR	PRECIP IN/HR
25	1.5	33	1.12	0.20	0.23
	2.0	35	1.50	0.24	0.27
	2.5	35	1.81	0.28	0.33
	3.0	36	2.26	0.34	0.39
	4.0	37	2.91	0.41	0.47
	5.0	39	3.72	0.47	0.54
	6.0	39	4.25	0.54	0.62
	8.0	36	5.90	0.88	1.01
35	1.5	34	1.35	0.22	0.26
	2.0	36	1.81	0.27	0.31
	2.5	37	2.17	0.31	0.35
	3.0	38	2.71	0.36	0.42
	4.0	40	3.50	0.42	0.49
	5.0	41	4.47	0.51	0.59
	6.0	43	5.23	0.54	0.63
	8.0	43	7.06	0.74	0.85
45	1.5	35	1.54	0.24	0.28
	2.0	37	2.07	0.29	0.34
	2.5	38	2.51	0.35	0.41
	3.0	40	3.09	0.37	0.43
	4.0	41	4.01	0.44	0.51
	5.0	43	5.09	0.48	0.56
	6.0	43	6.01	0.55	0.63
	8.0	43	8.03	0.70	0.81
55	1.5	35	1.71	0.27	0.31
	2.0	37	2.30	0.32	0.37
	2.5	37	2.76	0.39	0.45
	3.0	40	3.47	0.42	0.48
	4.0	42	4.44	0.48	0.56
	5.0	45	5.66	0.54	0.62
	6.0	47	6.63	0.58	0.67
	8.0	50	8.86	0.68	0.79
65	1.5	34	1.86	0.31	0.36
	2.0	35	2.52	0.40	0.46
	2.5	37	3.01	0.42	0.49
	3.0	40	3.78	0.45	0.53
	4.0	42	4.83	0.53	0.61
	5.0	45	6.16	0.59	0.68
	6.0	48	7.22	0.60	0.70
	8.0	50	9.63	0.74	0.86

Precipitation rates based on half circle throw

- \*PRECIP IN/H
- ▲ \*PRECIP IN/H



## 5000 Plus Rotors

Relax with the knowledge your landscape is being watered by reliable 5000 Series Rotors and industry-leading Rain Curtain Nozzle Technology. Rain Bird® 5000 Series Rotors are ideal for medium to large-size lawns and evenly distribute water from 25 to 50 feet.

- Plus Rotors have the added ability to shut off flow at the rotor



5000 PLUS • 3/4" FIPT

5000 PRS SERIES ROTOR		CASE QTY.	EACH
AX5004+PCSAMR	Pressure regulated with shut-off and SAM screen	20	\$ 47.32
AX5012+PCSR	12" Riser, Plus Series, Pressure Regulated and SAM screen	20	\$ 121.17
AX5004+FCSAM	Plus Full Circle	20	\$ 39.02
AX5004PLPC	Plus Part Circle, No SAM	20	\$ 34.79
AX5004+PCSAM	Plus Part Circle	20	\$ 39.00





3504PC

## 3500 Series Rotor

Easy to use short to mid-range 1/2" inlet gear-driven rotor sprinkler, offering value and top adjustment convenience for residential and light commercial sites with spacing up to 35 feet.

### Features:

- Radius adjustment screw allows up to 35% radius reduction without changing nozzles
- Top-adjust arc with flat blade screwdriver.
- Water-lubricated gear drive.
- 40° - 360° arc adjustment.



3500 SERIES ROTOR		CASE QTY.	EACH
AX3504PC	Part and full circle	20	\$ 39.09
AX3504PCSAM	Part and full circle	20	\$ 45.81



MAXI-PAW • 1/2" - 3/4" FIPT

## Maxi-Paw

The Maxi-Paw's powerful throw permits maximum spacing and offers superior close-in watering and uniform water distribution, ideal for dirty water applications with spacing up to 45 feet.

### Features:

- Ideal for effluent or non-potable water



MAXI-PAW		CASE QTY.	EACH
AX2045-08	Part/Full with #8 noz	20	\$ 75.45
AX2045-PJ-08 (MAXIBIRD)	Internal impact rotor	20	\$ 47.84
AX42064	Maxi-Paw Wrench	1	\$ 9.70
AXP206592	Nozzle 6, 7, 8, 10 & 12	100	N/A
AXP115902-07	Low Angle - Nozzle 7	100	N/A
AXP115902-10	Low Angle - Nozzle 10	100	N/A

\*\* #8 Nozzle is the Standard Nozzle



MAXIBIRD • 1/2" MIPT

### NOZZLE SET - 3500

PRESSURE PSI	NOZZLE	RADIUS FT.	FLOW GPM	PRECIP IN/HR	PRECIP IN/HR
25	0.75	15	0.54	0.46	0.53
	1.0	20	0.77	0.37	0.43
	1.5	23	1.06	0.39	0.45
	2.0	27	1.40	0.37	0.43
	3.0	29	2.17	0.50	0.57
35	4.0	31	2.97	0.59	0.69
	0.75	17	0.67	0.45	0.52
	1.0	21	0.92	0.40	0.46
	1.5	23	1.28	0.47	0.54
	2.0	27	1.69	0.45	0.52
45	3.0	31	2.60	0.52	0.60
	4.0	33	3.58	0.63	0.73
	0.75	17	0.77	0.51	0.59
	1.0	21	1.06	0.46	0.53
	1.5	24	1.48	0.49	0.57
55	2.0	27	1.93	0.51	0.59
	3.0	31	3.00	0.60	0.69
	4.0	35	4.13	0.65	0.75
	0.75	18	0.85	0.51	0.58
	1.0	22	1.18	0.47	0.54
	1.5	24	1.65	0.55	0.64
	2.0	28	2.15	0.53	0.61
	3.0	32	3.25	0.61	0.71
	4.0	35	4.60	0.72	0.83

■ \*PRECIP IN/H

▲ \*PRECIP IN/H

### NOZZLE SET - MAXIPAW, 2045PJ

PRESSURE PSI	NOZZLE	RADIUS FT.	FLOW GPM	PRECIP IN/HR	PRECIP IN/HR
25	7-BLK	22	2.2	0.41	0.48
	8-BLU	35	2.8	0.44	0.51
	10-YEL	38	4.2	0.56	0.65
	12-TAN	39	5.5	0.70	0.80
	6-RED	37	2.0	0.28	0.32
35	7-BLK	37	2.7	0.38	0.44
	8-BLU	38	3.3	0.44	0.51
	10-YEL	41	4.8	0.55	0.64
	12-TAN	42	6.3	0.69	0.79
	6-RED	38	2.3	0.31	0.35
45	7-BLK	39	3.0	0.38	0.44
	8-BLU	40	3.7	0.45	0.51
	10-YEL	42	5.0	0.59	0.68
	12-TAN	44	7.1	0.71	0.82
	6-RED	38	2.5	0.33	0.39
55	7-BLK	41	3.3	0.38	0.44
	8-BLU	41	4.1	0.47	0.54
	10-YEL	43	6.0	0.62	0.72
	12-TAN	45	7.9	0.75	0.87
	6-RED	38	2.6	0.35	0.40
60	7-BLK	41	3.5	0.40	0.46
	8-BLU	42	4.2	0.46	0.53
	10-YEL	44	6.4	0.64	0.74
	12-TAN	45	8.4	0.80	0.92

**RAIN BIRD**  
www.rainbird.com



8005 • 1" FIPT

## 8005 Series Rotors

These 1" inlet rotors are built rugged to withstand harsh conditions and vandalism in commercial applications such as athletic fields, schools, parks and commercial sites, with spacing up to 80 feet for the 8005.

**Features:**

- Left and right side trips adjustable for ease of installation without turning the case and loosening the pipe connection
- Seal-A-Matic check valve
- Memory Arc returns the rotor to its original arc setting
- Non-strippable drive mechanism prevents damage from vandals
- Sneaker Armor construction of nozzle, turret and riser withstands a vandals kick
- 5" pop-up height
- Stainless Steel Riser



8005 SERIES ROTOR		CASE QTY.	EACH
AX8005	Part/Full circle in one head	12	\$ 227.76
AX8005NP	W/ purple non-potable cover	12	\$ 229.20
AX8005SS	Stainless steel	12	\$ 238.16



FALCON 6504 • 1" FIPT

## Falcon 6504 Series Rotor

A 1" inlet heavy-duty, closed case rotor sprinkler with optional stainless steel riser, the Falcon 6504 rotor is ideal for large turf sites with spacing up to 65 feet.

**Features:**

- Easy, wet or dry arc adjustment (part circle model) 40° to 360°
- SAM check valve
- Rain Curtain Nozzles: 8x colour coded nozzles
- Ratcheting Stem: Quickly set the left edge of the Falcon rotor
- 4" pop-up height
- Available with stainless steel riser



FALCON 6504 SERIES ROTOR		CASE QTY.	EACH
AX6504PC	Part circle	12	\$ 122.12
AX6504FC	Full circle	12	\$ 122.12
AX6504PCSSH	FC/PC, Hi Speed, SS turret	12	\$ 370.24

### 8005 NOZZLE SET

PRESSURE PSI	NOZZLE	RADIUS FT.	FLOW GPM	PRECIP IN/HR	PRECIP IN/HR
50	12 TAN	57	11.1	0.66	0.76
	14 LT.GRN	59	12.6	0.70	0.81
	16 BRN	61	14.3	0.74	0.85
	18 DK. BLU	63	16.1	0.78	0.90
	20 RED	65	18.6	0.85	0.98
	22 YEL	65	20.7	0.94	1.09
	24 ORG	63	22.3	1.08	1.25
	26 WHT	65	24.3	1.11	1.28
60	12 TAN	59	12.0	0.66	0.77
	14 LT.GRN	61	14.3	0.74	0.85
	16 BRN	65	15.9	0.72	0.84
	18 DK. BLU	65	17.8	0.81	0.94
	20 RED	67	20.1	0.86	1.00
	22 YEL	71	23.2	0.89	1.02
	24 ORG	69	24.7	1.00	1.15
	26 WHT	73	26.7	0.96	1.11
70	12 TAN	59	13.2	0.73	0.84
	14 LT.GRN	63	15.3	0.74	0.86
	16 BRN	67	17.2	0.74	0.85
	18 DK. BLU	67	19.3	0.83	0.96
	20 RED	71	22.0	0.84	0.97
	22 YEL	73	25.2	0.91	1.05
	24 ORG	75	27.0	0.92	1.07
	26 WHT	75	29.4	1.01	1.16
80	12 TAN	61	14.2	0.73	0.85
	14 LT.GRN	63	16.4	0.80	0.92
	16 BRN	67	18.6	0.80	0.92
	18 DK. BLU	69	20.9	0.85	0.98
	20 RED	71	23.9	0.91	1.05
	22 YEL	75	27.3	0.93	1.08
	24 ORG	77	29.2	0.95	1.10
	26 WHT	79	31.5	0.97	1.12
90	12 TAN	61	14.7	0.76	0.88
	14 LT.GRN	65	17.9	0.82	0.94
	16 BRN	69	20.0	0.81	0.93
	18 DK. BLU	71	22.2	0.85	0.98
	20 RED	73	25.3	0.91	1.06
	22 YEL	75	29.1	1.00	1.15
	24 ORG	79	31.0	0.96	1.10
	26 WHT	79	33.7	1.04	1.20
100	20 RED	75	26.8	0.85	0.97
	22 YEL	77	30.7	1.00	1.15
	24 ORG	79	32.8	1.01	1.17
	26 WHT	81	36.3	1.07	1.23

Precipitation rates based on half circle throw

### 6504 NOZZLE SET

PRESSURE PSI	NOZZLE	RADIUS FT.	FLOW GPM	PRECIP IN/HR	PRECIP IN/HR
30	4 BLK	39	2.9	0.37	0.42
	6 BLU	43	4.2	0.44	0.50
	8 GRN	49	6.6	0.53	0.61
40	10 GRY	51	8.1	0.60	0.69
	12 TAN	53	9.7	0.66	0.77
	14 LT.GRN	55	11.3	0.72	0.83
	16 BRN	55	12.6	0.80	0.93
	18 DK. BLU	59	13.7	0.76	0.87
	20 RED	61	14.3	0.74	0.85
50	4 BLK	41	3.7	0.42	0.49
	6 BLU	49	5.5	0.44	0.51
	8 GRN	51	7.4	0.55	0.63
	10 GRY	53	9.1	0.62	0.72
	12 TAN	55	11.0	0.70	0.81
	14 LT.GRN	59	12.7	0.70	0.81
60	16 BRN	61	14.3	0.74	0.85
	18 DK. BLU	59	15.4	0.85	0.98
	4 BLK	41	4.0	0.46	0.53
	6 BLU	47	6.0	0.52	0.60
	8 GRN	51	8.2	0.61	0.70
	10 GRY	55	10.0	0.64	0.73
70	12 TAN	57	12.2	0.72	0.83
	14 LT.GRN	61	14.0	0.72	0.84
	16 BRN	63	15.7	0.76	0.88
	18 DK. BLU	63	17.1	0.83	0.96
	4 BLK	41	4.4	0.50	0.58
	6 BLU	49	6.3	0.51	0.58
80	8 GRN	51	8.9	0.66	0.76
	10 GRY	57	10.8	0.64	0.74
	12 TAN	59	13.2	0.73	0.84
	14 LT.GRN	61	15.2	0.79	0.91
	16 BRN	63	16.9	0.82	0.95
	18 DK. BLU	65	18.3	0.83	0.96
90	4 BLK	43	4.6	0.48	0.55
	6 BLU	49	6.9	0.55	0.64
	8 GRN	53	9.4	0.64	0.74
	10 GRY	55	11.6	0.74	0.85
	12 TAN	61	14.0	0.72	0.84
	14 LT.GRN	61	16.2	0.84	0.97
100	16 BRN	63	18.1	0.88	1.01
	18 DK. BLU	65	19.6	0.89	1.03

Precipitation rates based on half circle throw



**RAIN BIRD**



Available on the App Store

GET IT ON Google play

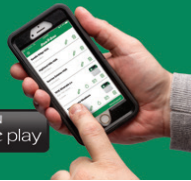

**RAIN BIRD**  
www.rainbird.com



WIFI COMPATIBLE



## ESP-ME3 Series Controllers

With 4 to 22 stations, the ESP-ME3 controller provides the station count options customers need. Install the same controller on residential and light commercial sites. Add station modules when expanding irrigation without removing or even powering down the controller. Upgrade the ESP-ME3 to a SMART controller with EPA WaterSense certification by adding the LNK WiFi module and WR2 rain sensor. The LNK makes programming and monitoring easy through the enhanced Rain Bird app. For even greater water monitoring and protection from a broken irrigation system, install a flow sensor.

### Features Include:

- WiFi Connectivity
- Flow Monitoring
- Flexible Installation
- Simplified Dial Programming
- Easy to Read Screen
- Bypass Rain Sensor by Station
- Seasonal Adjust by Program
- Alarm Notifications
- One-Touch Watering
- Contractor Default

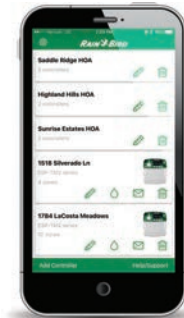

AXLINK-WIFI

AXWR2F - RAIN/FREEZE SENSOR

AXESPMOD3 & AXESPMODME6

ESP-ME3 SERIES CONTROLLER		CASE QTY.	EACH
AXESP4ME3	Indoor/Outdoor Controller w/WiFi	4	\$ 375.24

ACCESSORIES & MODULES		CASE QTY.	EACH
AXLINKWIFI	Wifi Module for ME3 & TM2	5	\$ 294.55
AXESP-MOD3	3 station module	12	\$ 110.24
AXESP-MODME6	6 station module	12	\$ 238.16

FLOW SENSOR		EACH
AXMJ100B	1" Brass Flow Sensor (Compatible w/ESP-ME3 Controller)	\$ 402.48

ESP MODULAR CONTROLLER		CASE QTY.	EACH
AXESP4MEIW	4 Station Indoor - Wifi Compatible	4	\$ 371.07



FLOW SENSOR

AXESP-4MEIW

## WR2F Series Wireless Rain Sensor



Rain Bird designed the WR2 wireless sensor to exceed the standard. With revolutionary features, this sensor saves time, improves system performance and enhances the contractor's reputation as a water management expert.



RAIN SENSOR		PRICE
AXWR2F	Rain Freeze Sensor & Receiver	\$ 228.60
AXRAINSTOP	Rain Sensor Wired	\$ 70.03
AXWR2BAT	Replacement Battery (Pack of 3)	\$ 15.86



WIFI  
COMPATIBLE



AXTM2

## TM2 Controller

The ESP-TM2 irrigation controller is the perfect option for basic residential solutions. With the flexibility of 3 programs and 4 start times available per program, you can tailor your watering schedule to your landscape's needs. The ESP-TM2 provides the Extra Simple Programming interface you are familiar with in a controller that is built to last!



Wifi Connectivity  
Simple to Program  
Suitable for Indoor and Outdoor

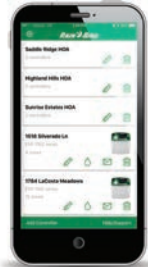

TM2 CONTROLLER		CASE QTY.	EACH
AXTM2-4	4 Station Controller - wifi compatible	6	\$ 279.76
AXTM2-6	6 Station Controller - wifi compatible	6	\$ 318.24
AXTM2-8	8 Station Controller - wifi compatible	6	\$ 377.52
AXTM2-12	12 Station Controller - wifi compatible	6	\$ 695.76
AXLINKWIFI	Wifi Module for ME3 & TM2	5	\$ 294.55

BLUETOOTH  
COMPATIBLE



## TBOS™

The TBOS-BT 9V Battery Controller provides commercial level irrigation control that you can program with your smartphone via the free Rain Bird mobile app.

TBOS™ BATTERY OPERATED CONTROLLER		PRICE
AXTBOS-BT1	1 station Bluetooth battery operated controller	\$ 478.40
AXTBOS-BT2	2 station Bluetooth battery operated controller	\$ 568.88
AXTBOS-BT4	4 station Bluetooth battery operated controller	\$ 678.08
AXTBOS-BT6	6 station Bluetooth battery operated controller	\$ 815.36
AXTBOSSOL	Latching Solenoid	\$ 102.15

## ESP-9V BATTERY-OPERATED CONTROLLER

Get reliable automatic irrigation control when you don't have AC power with the ESP-9V Series Battery-Operated Controller.

Installs Anywhere.  
Even Underwater.

The ESP-9V's waterproof case and dual-sealed battery chamber ensure long life even when installed in a wet, muddy valve box.

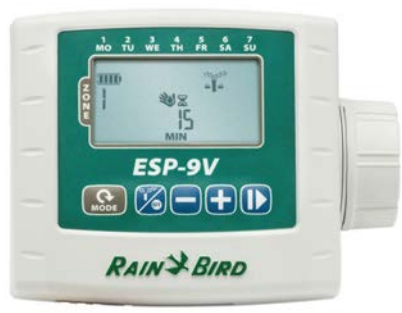

ESP-9V BATTERY-OPERATED CONTROLLER		PRICE
AXESP9V1	1 Station Battery-Operated Controller	\$ 247.43
AXESP9V2	2 Station Battery-Operated Controller	\$ 379.98
AXESP9V4	4 Station Battery-Operated Controller	\$ 468.35
AXESP9V6	6 Station Battery-Operated Controller	\$ 494.86



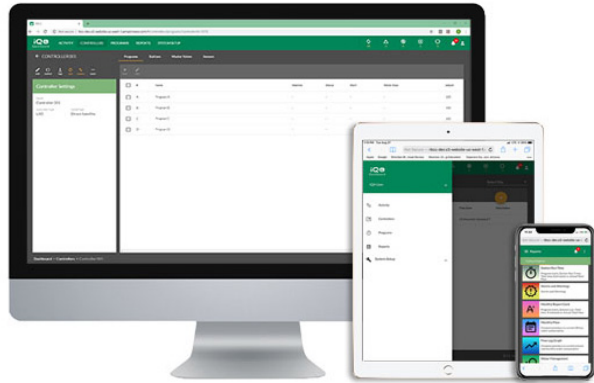

## Modular Multi-Site Central Control: IQ4

The IQ4 Platform offers state-of-the-art monitoring, programming and control features in an easy to learn user interface. IQ4 provides advanced water management features, saving you money and time. The IQ4 Platform consists of two options: IQ4-Cloud and IQ4-Desktop.



**IQ4-Cloud** - Cloud-enabled web-based service allowing users to login and control their irrigation system from any internet connected web-browser device. IQ4 is ideal for organizations with multiple irrigation system administrators and/or users that require mobility.

All IQ4 versions provide remote programming, management and monitoring of ESP-LX Series Controller from the computer to your office. IQ4 is the perfect irrigation control solution for parks departments, school districts, property managers, landscape maintenance contractors, and water managers.



**IQ4-Desktop** - Installed and operated on a single desktop computer. IQ4-Desktop is ideal for organizations with one administrator who can control the system from their computer in their office. The IQ4-Desktop software package provides 5-satellite controller capacity, and can be upgraded in 5-satellite increments.

**Module Compatibility:**

- ESP-LXME & ESP-LXMEF Series traditionally-wired controllers with 1 to 48 station capacity
- ESP-LXD Series Two-wire decoder controllers with 1 to 200 station capacity
- ESP-LXIVM Series IVM controller with 1 to 240 station capacity

## ESP-LXIVM Two-Wire Controller

Rain Bird's newest 2-Wire Controller has many new features, such as the Integrated Valve Module that stays in constant communication with the controller. This easy to install controller has a spacious case with multiple sized knockouts for wiring. The door and front panel are removable so the case can be easily mounted.

**Features Include:**

- 60 station capability with standard LX-IVM; 240 stations with the LX-IVM Pro
- Up to 5 flow sensor inputs; up to 10 inputs with LX-IVM Pro
- Removable front panel programmable under battery power
- UV and water resistant
- Optional remote water management system available using the IQ4 platform



ESP-LXIVM CONTROLLER		EACH
AXESPLXIVM	Two-wire Controller - up to 60 stations	\$ 2,548.00
AXESPLXIVMP	Two-wire Pro Controller - up to 240 stations	\$ 7,342.62
AXLXIVMSOL	Two-wire IVM Solenoid	\$ 451.15
AXLXIVMSEN	Two-wire IVM Sensor	\$ 1,467.79
AXLXIVMOUT	IVM Output Device	\$ 510.96
AXLXIVMSD	IVM Surge Device	\$ 226.74



AXESP LX MODULAR

## ESP LX Modular Controller

Features:

- Program backup and contractor restore.
- Seasonal adjustment by program or month.
- Enhanced Diagnostic Feedback™
- 12 Station can be expanded up to 48 station.
- Compatible with the Rain Bird IQ™ Central Control System.
- Programmable Valve Delay to allow for water well recovery or time for slow-closing valves to turn off.
- Cycle+Soak™ by station allows total irrigation time to be split into usable cycles, minimizing runoff.
- Master valve/pump start circuit, programmable by station, for optimal irrigation control.
- Flow module compatible



ESP LX CONTROLLERS		PRICE
AXESPLX12MEF	12 Station Base Outdoor - with flow	\$ 1,568.86
AXESPLX8ME	8 Station Modular Outdoor Controller	\$ 1,246.50
AXESPLXMOD8	8 Station Module	\$ 426.40
AXESPLXMOD12	12 Station Module	\$ 635.17
AXFSMLXME	Flow Smart Module	\$ 353.60
AXLXMM	Metal Cabinet	\$ 1,556.16
AXLXMMPED	Metal Pedestal	\$ 2,079.95



AXESP LX D

## ESP-LXD Decoder Controller

Features:

- The ESP-LXD controller has been designed to maintain the look, feel and ease of programming of the ESP-LXM controller but with an interface to a two-wire path for decoder-based irrigation.
- The ESP-LXD controller can manage up to 50 stations but can easily be expanded for use with up to 200 stations. Flow management is also built in to every ESP LXD.
- Decoders have their own addresses, an address is an exclusive connection. The ESP-LXD controller is linked to decoders in the field by a two-wire path. This path carries voltage and information. To allow watering, the ESP-LXD sends out a unique signal to one of the decoders on the two-wire path.

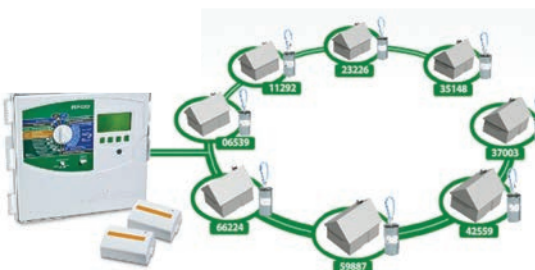

ESPLXD DECODER CONTROLLER		PRICE
AXESPLXD	50 Station Decoder Controller	\$ 3,491.31
AXLXDBUND	LXD Bundle (1 - ESPLXD, 15 - FD101T, 3 - LSP1T, 40 - DB)	\$ 8,479.62
AXESPLXD75	75 Expansion Module for LXD	\$ 993.14
AXLSP1T	Advanced surge protection (Yellow)	\$ 319.28
AXFD101T	Single Station/Single Valve Decoder	\$ 426.40
AXFD102T	Single Station/Double Valve Decoder	\$ 592.80
AXFD202T	2 Station Decoder	\$ 862.16
AXFD401T	4 Station Decoder	\$ 1,216.80



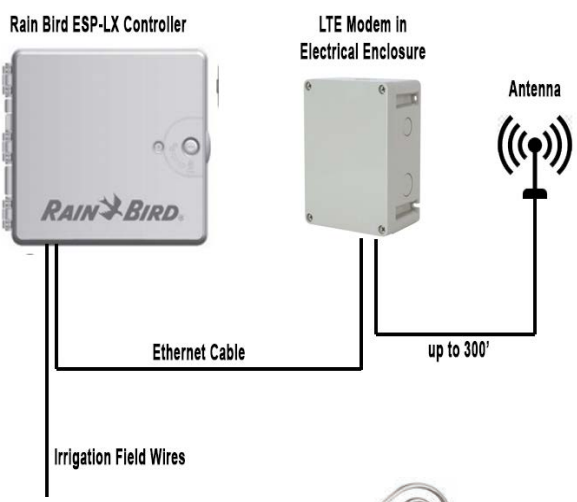

**Rain Bird IQ & LTE Modem**

Communication technology has been changing quickly. Service providers are beginning to offer 5G solutions while past communication methods are becoming obsolete. Vanden Bussche Irrigation has developed a unique solution in order to protect your budget while these communication platforms continue to evolve. Reach out to your Territory Manager to learn more about how this solution can work for you.

**SMRT-Y (Soil Moisture Sensor Kit)**

The SMRT-Y Soil Moisture Sensor Kit is an easy to install add-on to any standard irrigation system that directly links your irrigation controller to your landscapes moisture requirements. Program the controller to water every day that irrigation is allowed, and the soil moisture sensor will do the rest.



RAIN SENSOR		PRICE
AXSMRTY	Soil Moisture Sensor Kit	\$ 487.81

**Pump Start Relay**



PUMP START RELAYS - 110V and 220V		PRICE
AXPSR110IC	Universal Pump Start Relay - 110 volt unit - 3/4HP to 2HP	\$ 263.87
AXPSR220IC	Universal Pump Start Relay - 220 volt unit - 3/4HP to 5HP	\$ 263.87

**IRRIGATION DESIGN SERVICES**

Vanden Bussche Irrigation provides irrigation design services for commercial, golf, and large residential properties.

Send us a landscape drawing with the necessary water source information, and we'll provide you with:

- A detailed irrigation design
- A material list & quote
- Installation details
- Critical Analysis & watering schedule

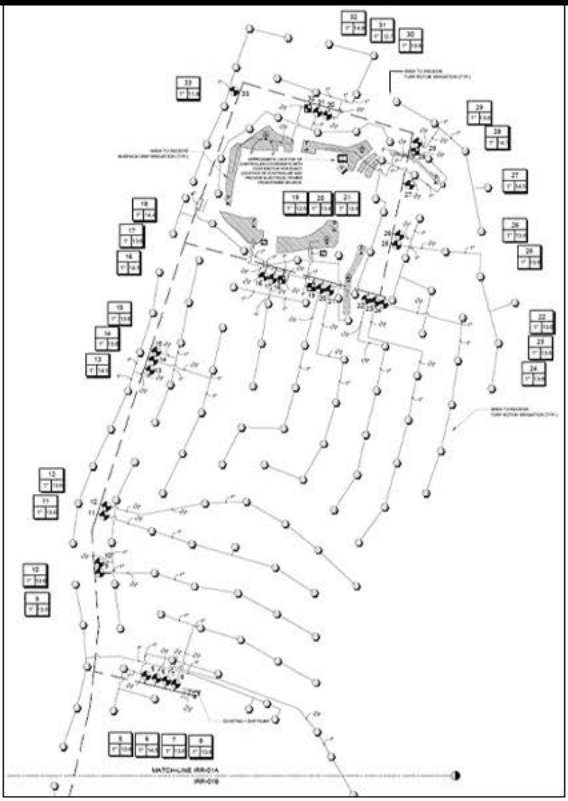

Contact your local Vanden Bussche representative or email us at [info@vandenbussche.com](mailto:info@vandenbussche.com)

## Sensors & Sensor Modules

SENSORS		PRICE
AXIQ4620	IQFSCMLXME flow smart connection module for ESPLXME	\$ 937.11
AXM61010	4" Raincan	\$ 1,352.00



RS-232 CARTRIDGE INSTALLED IN ESP-LX

## Communication Cartridges

COMMUNICATION CARTRIDGES		P.O.R
AXIQ4600	IQNCCRS RS-232 network communication cartridge	P.O.R
AXIQ4603	IQNCCEN ethernet communication cartridge	P.O.R
AXIQ4613	IQNCC 3G communication cartridge	P.O.R
AXIQ4613D	IQ3GT 1 Year data communication	P.O.R
AXIQ4621	IQCMLXD connection module for ESPLXD	P.O.R
AXIQ4630	IQSSRADIO spread spectrum radio 900MHz	P.O.R

## Communication Accessories

COMMUNICATION ACCESSORIES		PRICE
AXIQ3011	IQNCCM null modem cable	\$ 86.79
AXIQ4640	IQEXTANTGP GPRS/cellular external antenna	\$ 300.83

## MOBILE DATA

Your one stop provider for cellular connectivity. We offer cellular SIM cards and modems with no commitments or contracts.

Simplified rates and easy setup. Pay monthly, quarterly or annually.

CONTACT US  
For SIM cards and  
Modems

**iLeague**  
WIRELESS



289 999-2304

Email: [sales@ileaguewireless.com](mailto:sales@ileaguewireless.com)

[www.ileaguewireless.com](http://www.ileaguewireless.com)



## HV Valve Series

### Features:

- Eccentric diaphragm for smooth closing, less water hammer
- Compact design, 2.54" spin radius for tight installations
- Glass-filled polypropylene body for strength
- Flow 0.2 - 30 gpm; Pressure 15 - 150 psi



AX100HV



HV VALVE SERIES		CASE QTY.	PRICE
AX100HV	1" FIPT x FIPT	20	\$ 40.98
AX100HVMB	1" MIPT x Insert	20	\$ 44.15
AXP236307	HV Valve Solenoid Kit - parts discount applicable	10	\$ 35.72

## DV/DVF Valve Series

### Features:

- Double-filtered pilot-flow design
- Balanced-pressure diaphragm for long life
- (DVF) Unique, easy-to-turn pressure-assisted flow control mechanism
- Flow 2 - 40 gpm; Pressure 15 - 150 psi



DIAPHRAGM KIT



AX100DVM



DV VALVE SERIES		CASE QTY.	PRICE
AX075DV	3/4" FIPT x FIPT	20	\$ 58.35
AX100DV	1" FIPT x FIPT	20	\$ 53.82
AX100DVM	1" MIPT x Insert	20	\$ 52.99
AX100DVF	1" FIPT x FIPT Flow Control	20	\$ 61.91
AXP208588-01	DV Solenoid - parts discount applicable	10	\$ 35.72
AXP210746-03	Diaphragm kit for 100 DV/DVF - parts discount applicable	20	\$ 28.13

## PGA Valve Series

### Features:

- Globe and angle configuration for flexibility in design and installation
- Double-filtered pilot-flow to resist debris and clogging of solenoid ports
- Slow closing to prevent water hammer and subsequent system damage
- Manual internal bleed operates the valve without allowing water into the valve box
- Pressure 15 - 150 psi



AX150PGA



PGA VALVE SERIES		CASE QTY.	PRICE
AX100PGA	1" Globe/Angle	10	\$ 79.41
AX150PGA	1 1/2" Globe/Angle	8	\$ 217.36
AX200PGA	2" Globe/Angle	4	\$ 304.72
AXP236239	PGA Solenoid - parts discount applicable	10	\$ 72.68

## Heavy Duty PESB Valve Series

Industrial-strength glass-filled nylon globe valve for commercial applications. Rain Bird's most durable plastic valve. Also available with self-cleaning scrubber and stainless steel screen for reliable performance in commercial dirty water applications.



AX150PESB



PESB VALVE SERIES		CASE QTY.	PRICE
AX100PESB	1" w/scrubber	12	\$ 404.41
AX150PESB	1 1/2" w/scrubber	8	\$ 483.19
AX200PESB	2" w/scrubber	8	\$ 609.23
AXP236483	Diaphragm for 200 PESB	1	\$ 145.96
AX300BPES	3" Brass w/ scrubber	1	\$ 1,655.67
AXPRS-DIAL	Pressure regulation unit	10	\$ 194.78
AXP236239	PGA Solenoid - parts discount applicable	10	\$ 72.68



AX150EFBCP



BRASS VALVES		CASE QTY.	PRICE
AX100EFB-CP	1" Brass Valve	12	\$ 414.96
AX150EFBCP	1 1/2" Brass Valve	10	\$ 659.88
AX200EFB-CP	2" Brass Valve	8	\$ 789.31

## Flow Meters & Hydrometers

Netafim flow meters and Rain Bird flow sensors send flow data to central control or stand-alone control systems for precise and accurate flow monitoring.

- Requires installation between 10 x the diameter of straight pipe before the unit and 5 x the unit after
- Netafim Hydrometers allow for flow monitoring coupled with a master valve in a single unit without the straight pipe requirements.



1 1/2" & 2" (HM)



3" & 4" (HM)



3/4", 1" & 1 1/2" (WM)



2" (WM)



3" & 4" (WM)

## Netafim Flow Meters & Hydrometers

### FLOW METERS

PART #	SIZE	GALLONS PER PULSE	MIN. FLOW	CONNECTIONS	PRICE
ATLHM15TG1-MEL	1 1/2"	1	1.8	Threaded	\$ 1,712.15
ATLHM2TG1-MEL	2"	1	5.3	Threaded	\$ 1,802.50
ATLHM3FG1-MEL	3"	1	14	Flanged	\$ 2,473.00
ATLHM4FG1-MEL	4"	1	21	Flanged	\$ 3,832.00
ATWM-075-0.1-RS-M	3/4"	0.1	0.2	Threaded	\$ 288.00
ATWM-075-1.0-RS-M	3/4"	1	0.2	Threaded	\$ 288.00
ATWM-100-1.0-RS-M	1"	1	0.3	Threaded	\$ 480.00
ATWM-150-1.0-RS	1 1/2"	1	0.9	Threaded	\$ 911.00
ATWM-200-10-RS	2"	10	2	Threaded	\$ 936.00
ATWMW-300-10-RS	3"	10	2	Flanged	\$ 1,547.00
ATWMW-400-10-RS	4"	10	4	Flanged	\$ 1,975.00

## Rain Bird Flow Tees

### BRASS TEE FLOW SENSORS

PART #	SIZE	MODEL	MIN. FLOW	CONNECTIONS	PRICE
AXM80101	1"	FS100B	2	MIPT	\$ 1,566.29
AXM80110	1 1/2"	FS150B	4	MIPT	\$ 2,368.70
AXM80111	2"	FS200B	10	FIPT	\$ 2,736.23

### PVC TEE FLOW SENSORS

PART #	SIZE	MODEL	MIN. FLOW	CONNECTIONS	PRICE
AXM80108	1"	FS100P	5.4	PVC Socket	\$ 1,578.65
AXM80102	1 1/2"	FS150P	5	PVC Socket	\$ 1,691.96
AXM80103	2"	FS200P	10	PVC Socket	\$ 2,069.69
AXM80104	3"	FS300P	20	PVC Socket	\$ 2,268.73
AXM80107	4"	FS400P	40	PVC Socket	\$ 2,256.09

### FLOW SENSOR

PART #	DESCRIPTION	PRICE
AXMJ100B	1" Brass Flow Sensor (Compatible w/ESP-ME3 Controller)	\$ 387.00



Brass Flow Tee



Plastic Flow Tee



Rain Bird Flow Sensor



HC Flow Meters

## Hunter/Hydrawise Flow Meters

PART #	SIZE	MIN. FLOW (GPM)	CONNECTIONS	CASE QTY.	PRICE
PDHC075FLOW	3/4"	0.22	NPT	10	\$ 352.08
PDHC100FLOW	1"	0.3	NPT	1	\$ 394.42
PDHC150FLOW	1 1/2"	0.88	NPT	1	\$ 838.91
PDHC200FLOW	2"	1.98	NPT	1	\$ 1,120.96

PART #	DESCRIPTION	PRICE
PDWFS	Wireless Flow Sensor	\$ 851.81

## Flowmec QS200 Insertion Ultrasonic Flowmeter

PART #	SIZE	MIN. FLOW (GPM)	CONNECTIONS	PRICE
ORQS200	Insert Only			\$ 1,024.74
ORQS200-10	1"	.22	PVC Female Socket	\$ 1,144.77
ORQS200-15	1 1/2"	.55	PVC Female Socket	\$ 1,203.97
ORQS200-20	2"	.92	PVC Female Socket	\$ 1,272.74
ORQS200-30	3"	2.06	PVC Female Socket	\$ 1,446.34
ORQS200-40	4"	3.58	PVC Female Socket	\$ 1,522.72





# THE **INDUSTRY STANDARD** JUST RAISED THE BAR. AGAIN.



Get 23 conventional stations with the PCM-1600 module

Or enable two-wire for up to 32 stations with the PC-DM module

## GET MORE OUT OF YOUR PRO-C® CONTROLLER

New plug-in modules increase conventional Pro-C station counts and enable two-wire or hybrid conventional/two-wire control with the revolutionary Hunter EZ Decoder System. The freedom and flexibility of more stations in more configurations keeps the trusted Pro-C an affordable and reliable solution for residential and light commercial projects. *That's the power of innovation.*



EZ-1 Decoder

RESIDENTIAL & COMMERCIAL IRRIGATION | Built on Innovation®  
Learn more. Visit [hunter.direct/pcm](http://hunter.direct/pcm)

# Hunter®



ACCESS EVEN THE MOST INACCESSIBLE PLACES

## PROGRAM FROM OUTSIDE THE VALVE BOX WITH THE NEW NODE-BT BLUETOOTH® CONTROLLER.

Easily manage NODE-BT from a smartphone app. Install the battery-operated, waterproof controller in areas where AC power is unavailable. For faster maintenance, the app maps controllers by location and sends convenient battery-change reminders. It's that easy!

WITH NODE-BT, you can configure the controller up to 50' (15 m) away.



The Bluetooth® word mark and logos are registered trademarks owned by Bluetooth SIG Inc. and any use of such marks by Hunter Industries is under license. Apple and the Apple logo are trademarks of Apple Inc. App Store is a service mark of Apple Inc. IOS is a trademark or registered trademark of Cisco in the U.S. and other countries and is used under license. Google, the Google logo, Google Play, and Android are trademarks of Google LLC.



RESIDENTIAL & COMMERCIAL IRRIGATION | Built on Innovation®  
Learn more. Visit [hunterindustries.com](http://hunterindustries.com)

# Hunter®

# Hunter®

www.hunterindustries.com

## Spray Heads

Your different project and budgeting watering requirements are met by Hunter's many different 1/2" inlet spray heads.

### Pro-Spray features:

- Designed for the contractor
- Pressure-activated no-flow by wiper seal
- Ratcheting riser
- Heavy-duty spring
- Innovative "pull up" flush plug design
- Compatible with all female threaded nozzles



PRO-SPRAY		CASE QTY.	PRICE
PDPROS04	4"	50	\$ 3.89
PDPROS06SI	6"	25	\$ 18.60
PDPROS12SI	12"	25	\$ 28.92

### PRS30 - Brown cap

Replaces Hunter's former Institutional sprays keeping water pressure at a true 30PSI to reduce waste and maximize performance.

PRO-SPRAY PRESSURE REGULATED TO 30 PSI		CASE QTY.	PRICE
PDPROS04PRS30	4"	50	\$ 15.49
PDPROS06PRS30	6"	25	\$ 35.63
PDPROS12PRS30	12"	25	\$ 41.31

### PRS40 - Grey cap

Like the former institutional sprays but designed at 40PSI with a check valve for optimal performance when paired with the MP ROTATOR.

PRO-SPRAY PRESSURE REGULATED TO 40 PSI		CASE QTY.	PRICE
PDPROS04PRS40CV	4"	50	\$ 19.88
PDPROS06PRS40CV	6"	25	\$ 45.44
PDPROS12PRS40CV	12"	25	\$ 53.69

For use with MP Rotator Nozzles

SHRUB ADAPTER		BAG QTY.	PRICE
PDPROS00	1/2" FIPT x Noz TH	50	\$ 2.15

### STRIP SERIES

ARC	PRESSURE PSI			FLOW GPM
		WIDTH	LENGTH	
SNLCS515	20	4	14	0.55
	25	5	15	0.60
	30	5	15	0.65
SNRCS515	35	5	15	0.70
	20	4	14	0.55
	25	5	15	0.60
SNRCS515	30	5	15	0.65
	35	5	15	0.70
	20	4	28	1.10
SNSS530	25	5	30	1.20
	30	5	30	1.30
	35	5	30	1.40
SNES515	20	4	14	0.55
	25	5	15	0.60
	30	5	15	0.65
SNES515	35	5	15	0.70
	20	4	28	1.10
	25	5	30	1.20
SNCS530	30	5	30	1.30
	35	5	30	1.40
	20	8	17	1.45
SNSS918	25	9	18	1.58
	30	9	18	1.72
	35	9	18	1.88





# Landscape Irrigation Products

# Hunter®

www.hunterindustries.com

## Spray Nozzles

Hunter's own complete line of adjustable, fixed and specialty nozzles

### PRO-SPRAY SERIES NOZZLES

ARC	PRESSURE PSI	SN5 BLUE 0° TRAJECTORY				SN8 BROWN 0° TRAJECTORY				SN10 RED 15° TRAJECTORY				SN12 GREEN 28° TRAJECTORY				SN15 BLACK 28° TRAJECTORY				SN17 GREY 28° TRAJECTORY			
		RADIUS ft.	FLOW GPM	■ PRECIP IN/H	▲ PRECIP IN/H	RADIUS ft.	FLOW GPM	■ PRECIP IN/H	▲ PRECIP IN/H	RADIUS ft.	FLOW GPM	■ PRECIP IN/H	▲ PRECIP IN/H	RADIUS ft.	FLOW GPM	■ PRECIP IN/H	▲ PRECIP IN/H	RADIUS ft.	FLOW GPM	■ PRECIP IN/H	▲ PRECIP IN/H	RADIUS ft.	FLOW GPM	■ PRECIP IN/H	▲ PRECIP IN/H
F	20	4	0.37	2.25	2.60	7	0.78	1.54	1.78	9	1.29	1.53	1.77	11	2.17	1.72	1.99	14	3.04	1.49	1.72	Use Hunter 17A Nozzle			
	25	4	0.42	2.54	2.94	8	0.88	1.33	1.53	10	1.45	1.39	1.61	12	2.45	1.63	1.89	15	3.41	1.46	1.69				
	30	5	0.47	1.80	2.08	8	0.97	1.46	1.69	10	1.59	1.53	1.76	12	2.70	1.80	2.08	15	3.75	1.61	1.85				
	35	6	.051	1.36	1.57	9	1.05	1.25	1.45	11	1.72	1.37	1.58	13	2.93	1.67	1.93	16	4.07	1.53	1.76				
	40	6	.055	1.46	1.69	10	1.13	1.34	1.55	11	1.84	1.46	1.69	13	3.15	1.80	2.07	17	4.36	1.45	2.68				
H	20	4	0.19	2.25	2.60	7	0.38	1.49	1.72	9	0.70	1.67	1.92	11	1.05	1.67	1.93	14	1.51	1.48	1.71	16	1.91	1.43	1.66
	25	4	0.21	2.54	2.94	8	0.43	1.28	1.48	10	0.79	1.53	1.76	12	1.18	1.58	1.83	15	1.69	1.45	1.67	17	2.15	1.43	1.65
	30	5	0.23	1.80	2.08	8	0.47	1.41	1.63	10	0.88	1.69	1.95	12	1.30	1.74	2.01	15	1.86	1.59	1.84	17	2.37	1.58	1.82
	35	6	0.25	1.36	1.57	9	0.51	1.21	1.39	11	0.95	1.52	1.75	13	1.42	1.61	1.86	16	2.02	1.52	1.75	18	2.57	1.53	1.76
	40	6	0.27	1.46	1.69	9	0.54	1.29	1.49	11	1.03	1.63	1.89	13	1.52	1.73	2.00	17	2.16	1.44	1.66	19	2.76	1.47	1.70
Q	20	4	0.09	2.25	2.60	7	0.20	1.54	1.78	9	0.34	1.63	1.88	11	0.54	1.71	1.98	14	0.78	1.53	1.77	16	0.93	1.40	1.61
	25	4	0.11	2.54	2.94	8	0.22	1.33	1.53	10	0.39	1.48	1.71	12	0.61	1.62	1.87	15	0.88	1.51	1.74	17	1.05	1.39	1.61
	30	5	0.12	1.80	2.08	8	0.24	1.46	1.69	10	0.42	1.63	1.89	12	0.67	1.78	2.06	15	0.97	1.67	1.92	17	1.15	1.54	1.77
	35	6	0.13	1.36	1.57	9	0.26	1.25	1.45	11	0.46	1.47	1.69	13	0.72	1.65	1.90	16	1.06	1.59	1.84	18	1.25	1.49	1.72
	40	6	0.14	1.46	1.69	9	0.28	1.34	1.55	11	0.49	1.57	1.82	13	0.78	1.77	2.04	17	1.14	1.52	1.75	19	1.34	1.43	1.65

■ \*PRECIP IN/H  
▲ \*PRECIP IN/H

HUNTER SPRAY NOZZLES	BAG QTY.	PRICE	
PRO-SERIES NOZZLES	See chart for part no.	25	\$ 2.65
STRIP SERIES NOZZLES	See chart for part no.	25	\$ 2.65
ADJUSTABLE ARC NOZZLES	See chart for part no.	25	\$ 2.63

\*\*See pg. 48 for details

### PRO-ADJUSTABLE ARC NOZZLES

ARC	PRESSURE PSI	SN4A LIGHT GREEN 0° TRAJECTORY				SN6A BLUE 15° TRAJECTORY				SN8A BROWN 0° TRAJECTORY				SN10A RED 15° TRAJECTORY				SN12A GREEN 28° TRAJECTORY				SN15A BLACK 28° TRAJECTORY				SN17A GREY 28° TRAJECTORY			
		RADIUS ft.	FLOW GPM	■ PRECIP IN/H	▲ PRECIP IN/H	RADIUS ft.	FLOW GPM	■ PRECIP IN/H	▲ PRECIP IN/H	RADIUS ft.	FLOW GPM	■ PRECIP IN/H	▲ PRECIP IN/H	RADIUS ft.	FLOW GPM	■ PRECIP IN/H	▲ PRECIP IN/H	RADIUS ft.	FLOW GPM	■ PRECIP IN/H	▲ PRECIP IN/H	RADIUS ft.	FLOW GPM	■ PRECIP IN/H	▲ PRECIP IN/H	RADIUS ft.	FLOW GPM	■ PRECIP IN/H	▲ PRECIP IN/H
90°	20	3	0.19	4.57	5.28	5	0.30	3.21	3.70	7	0.23	1.83	2.11	9	0.39	1.86	2.15	11	0.50	1.60	1.85	14	0.74	1.46	1.69	16	0.96	1.44	1.67
	25	3	0.20	4.81	5.56	5	0.31	3.32	3.83	8	0.26	1.58	1.83	10	0.44	1.71	1.97	12	0.57	1.52	1.76	15	0.84	1.44	1.66	17	1.09	1.45	1.67
	30	4	0.28	6.74	7.78	6	0.37	3.96	4.57	8	0.29	1.75	2.02	10	0.49	1.89	2.18	12	0.63	1.68	1.95	15	0.93	1.59	1.84	17	1.20	1.60	1.85
	35	4	0.24	5.78	6.67	6	0.38	4.06	4.69	9	0.32	1.51	1.74	11	0.53	1.70	1.96	13	0.69	1.56	1.80	16	1.01	1.52	1.76	18	1.31	1.55	1.79
	40	4	0.25	5.90	6.81	6	0.40	4.28	4.94	9	0.34	1.62	1.87	11	0.57	1.83	2.11	13	0.74	1.68	1.94	17	1.09	1.45	1.68	19	1.41	1.50	1.73
180°	20	3	0.34	4.09	4.72	5	0.50	2.67	3.09	7	0.47	1.83	2.11	9	0.78	1.86	2.15	11	1.01	1.60	1.85	14	1.49	1.46	1.69	16	1.92	1.44	1.67
	25	3	0.38	4.57	5.28	5	0.54	2.89	3.33	8	0.53	1.58	1.83	10	0.89	1.71	1.97	12	1.14	1.52	1.76	15	1.68	1.44	1.66	17	2.17	1.45	1.67
	30	4	0.45	5.41	6.25	6	0.60	3.21	3.70	8	0.58	1.75	2.02	10	0.98	1.89	2.18	12	1.26	1.68	1.95	15	1.86	1.59	1.84	17	2.40	1.60	1.85
	35	4	0.46	5.53	6.39	6	0.64	3.42	3.95	9	0.63	1.51	1.74	11	1.07	1.70	1.96	13	1.37	1.56	1.80	16	2.02	1.52	1.76	18	2.61	1.55	1.79
	40	4	0.48	5.78	6.67	6	0.68	3.64	4.20	9	0.68	1.62	1.87	11	1.15	1.83	2.11	13	1.48	1.68	1.94	17	2.18	1.45	1.68	19	2.81	1.50	1.73
270°	20	3	0.59	4.73	5.46	5	0.88	3.14	3.62	7	0.70	1.83	2.11	9	1.18	1.86	2.15	11	1.51	1.60	1.85	14	2.23	1.46	1.69	16	2.88	1.44	1.67
	25	3	0.66	5.29	6.11	5	0.98	3.49	4.03	8	0.79	1.58	1.83	10	1.33	1.71	1.97	12	1.71	1.52	1.76	15	2.52	1.44	1.66	17	3.26	1.45	1.67
	30	4	0.73	5.86	6.76	6	1.10	3.92	4.53	8	0.87	1.75	2.02	10	1.47	1.89	2.18	12	1.89	1.68	1.95	15	2.79	1.59	1.84	17	3.60	1.60	1.85
	35	4	0.76	6.10	7.04	6	1.15	4.10	4.73	9	0.95	1.51	1.74	11	1.60	1.70	1.96	13	2.06	1.56	1.80	16	3.04	1.52	1.76	18	3.92	1.55	1.79
	40	4	0.80	6.42	7.41	6	1.20	4.28	4.94	9	1.02	1.62	1.87	11	1.72	1.83	2.11	13	2.21	1.68	1.94	17	3.27	1.45	1.68	19	4.22	1.50	1.73
360°	20	3	0.66	3.97	4.58	5	1.05	2.81	3.24	7	0.93	1.83	2.11	9	1.57	1.86	2.15	11	2.02	1.60	1.85	14	2.98	1.46	1.69	16	3.84	1.44	1.67
	25	3	0.72	4.33	5.00	5	1.10	2.94	3.40	8	1.05	1.58	1.83	10	1.77	1.71	1.97	12	2.28	1.52	1.76	15	3.37	1.44	1.66	17	4.34	1.45	1.67
	30	4	0.80	4.81	5.56	6	1.26	3.37	3.89	8	1.16	1.75	2.02	10	1.96	1.89	2.18	12	2.52	1.68	1.95	15	3.72	1.59	1.84	17	4.80	1.60	1.85
	35	4	0.86	5.17	5.97	6	1.30	3.48	4.01	9	1.27	1.51	1.74	11	2.13	1.70	1.96	13	2.74	1.56	1.80	16	4.05	1.52	1.76	18	5.22	1.55	1.79
	40	4	0.90	5.41	6.25	6	1.40	3.74	4.32	9	1.36	1.62	1.87	11	2.30	1.83	2.11	13	2.95	1.68	1.94	17	4.36	1.45	1.68	19	5.62	1.50	1.73

■ \*PRECIP IN/H  
▲ \*PRECIP IN/H

# Hunter®

www.hunterindustries.com



**MP ROTATOR™**

A Matched Precipitation Sprinkler for Turf & Landscape



**Features:**

- True matched precipitation with any arc or radius setting
- Radius can be reduced up to 25% on all models
- Applies additional water first 3' from the pop-up when head to head coverage is not available



**Operating Specifications:**

- Recommended operating pressure is 40 PSI
- Models can only be adjusted while water is running
- Install with "PRS40 Grey Cap Spray Heads" for maximum efficiency

MP800 Series		BAG QTY.	PRICE
PDMP800SR90 - ORANGE	Short Radius 6'-12' 90°-210°	10	\$ 19.59
PDMP800SR360 - LIME GREEN	Short Radius 6'-12', 360°	10	\$ 19.59

MP 1000 • 12' - 15' RADIUS		BAG QTY.	PRICE
PDMP100090 - MAROON	90° - 210°	10	\$ 19.59
PDMP1000210 - LIGHT BLUE	210° - 270°	10	\$ 19.59
PDMP1000360 - OLIVE	360°	10	\$ 19.59

MP 2000 • 17' - 22'		BAG QTY.	PRICE
PDMP200090 - BLACK	90° - 210°	10	\$ 19.59
PDMP2000210 - GREEN	210° - 270°	10	\$ 19.59
PDMP2000360 - RED	360°	10	\$ 19.59

MP 3000 • 25' - 30'		BAG QTY.	PRICE
PDMP300090 - BLUE	90° - 210°	10	\$ 19.59
PDMP3000210 - YELLOW	210° - 270°	10	\$ 19.59
PDMP3000360 - GREY	360°	10	\$ 19.59

MP3500 • 35'		BAG QTY.	PRICE
PDMP350090	90° - 210°	10	\$ 19.59

SPECIALTY NOZZLES AND TOOLS		BAG QTY.	PRICE
PDMPRCS515 - COPPER	Right Corner Strip 5' X 15'	10	\$ 19.59
PDMP LCS515 - IVORY	Left Corner Strip 5' x 15'	10	\$ 19.59
PDMPSS530 - BROWN	Side strip 5' x 30'	10	\$ 19.59
PDMP CORNER - TURQUOISE	Corner, 8'-15', 45° - 105°	10	\$ 19.59
PDMP TOOL	Adjustment tool (orange)	10	\$ 2.82



**MP CORNER**

ARC	PRESSURE PSI	45° - 105° - Turquoise		
		RADIUS ft.	FLOW GPM	FLOW GPH
25	-	-	-	-
30	12	0.17	10.2	
35	13	0.18	10.8	
40	14	0.19	11.4	
45	14	0.21	12.6	
50	14	0.22	13.2	
55	15	0.23	13.8	
45°	25	11	0.31	18.6
	30	12	0.34	20.4
	35	13	0.36	21.6
	40	14	0.39	23.4
	45	14	0.41	24.6
	50	14	0.43	25.8
	55	15	0.46	27.6
90°	25	11	0.36	21.6
	30	12	0.39	23.4
	35	13	0.42	25.2
	40	14	0.45	27
	45	14	0.48	28.8
	50	15	0.51	30.6
	55	15	0.53	31.8

**NOZZLE MODEL**

NOZZLE MODEL	PRESSURE PSI	Color		
		WIDTH ' X LENGTH'	FLOW GPM	FLOW GPH
MP LEFT STRIP	30	4 x 14	0.19	11.4
	35	5 x 15	0.21	12.6
	40	5 x 15	0.22	13.2
	45	5 x 15	0.23	13.8
	50	6 x 16	0.25	15
	55	6 x 16	0.26	15.6
MP RIGHT STRIP	30	4 x 14	0.19	11.4
	35	5 x 15	0.21	12.6
	40	5 x 15	0.22	12.2
	45	5 x 15	0.23	13.8
	50	6 x 16	0.25	15
	55	6 x 16	0.26	15.6
MP SIDE STRIP	30	4 x 28	0.38	22.8
	35	5 x 30	0.41	24.6
	40	5 x 30	0.44	26.4
	45	5 x 30	0.47	28.2
	50	6 x 32	0.49	29.4
	55	6 x 32	0.51	30.6

**MP ROTATOR**

ARC	PRESSURE PSI	MP 1000				MP 2000				MP 3000			
		RADIUS ft.	FLOW GPM	PRECIP IN/H	PRECIP IN/H	RADIUS ft.	FLOW GPM	PRECIP IN/H	PRECIP IN/H	RADIUS ft.	FLOW GPM	PRECIP IN/H	PRECIP IN/H
360°	25	-	-	-	-	16	1.16	0.44	0.50	25	2.88	0.44	0.51
	30	12.0	0.65	0.43	0.50	17	1.27	0.42	0.49	27	3.15	0.42	0.48
	35	13.0	0.71	0.40	0.47	18	1.37	0.41	0.47	28	3.40	0.42	0.48
	40	13.5	0.75	0.39	0.46	19	1.47	0.39	0.45	30	3.64	0.39	0.45
	45	14.0	0.80	0.39	0.45	20	1.56	0.38	0.43	30	3.86	0.41	0.48
	50	14.5	0.84	0.38	0.44	21	1.64	0.36	0.41	30	4.07	0.44	0.50
55	15.0	0.87	0.37	0.43	21	1.70	0.37	0.43	30	4.27	0.46	0.53	
270°	25	-	-	-	-	16	0.87	0.44	0.50	25	2.19	0.45	0.51
	30	12	0.48	0.43	0.50	17	0.95	0.42	0.49	27	2.37	0.42	0.48
	35	13	0.54	0.40	0.46	18	1.03	0.41	0.47	28	2.55	0.42	0.48
	40	14	0.57	0.39	0.45	19	1.10	0.39	0.45	30	2.73	0.39	0.45
	45	14	0.60	0.39	0.45	20	1.17	0.38	0.43	30	2.89	0.41	0.48
	50	14	0.63	0.38	0.43	21	1.23	0.36	0.41	30	3.06	0.44	0.50
55	15	0.66	0.37	0.43	21	1.30	0.37	0.43	30	3.22	0.46	0.53	
210°	25	-	-	-	-	16	0.68	0.44	0.50	25	1.68	0.44	0.52
	30	12.0	0.37	0.43	0.50	17	0.74	0.42	0.49	27	1.84	0.42	0.48
	35	13.0	0.41	0.40	0.46	18	0.80	0.41	0.47	28	1.99	0.42	0.48
	40	13.5	0.43	0.39	0.45	19	0.86	0.39	0.45	30	2.12	0.39	0.45
	45	14.0	0.46	0.39	0.45	20	0.92	0.38	0.43	30	2.25	0.41	0.48
	50	14.5	0.48	0.38	0.43	21	0.97	0.36	0.41	30	2.37	0.44	0.50
55	15.0	0.50	0.37	0.43	21	1.01	0.37	0.43	30	2.49	0.46	0.53	
180°	25	-	-	-	-	16	0.58	0.44	0.50	25	1.44	0.44	0.51
	30	12.0	0.32	0.43	0.50	17	0.63	0.42	0.49	27	1.58	0.42	0.48
	35	13.0	0.35	0.40	0.46	18	0.69	0.41	0.47	28	1.70	0.42	0.48
	40	13.5	0.37	0.39	0.45	19	0.74	0.39	0.45	30	1.82	0.39	0.45
	45	14.0	0.40	0.39	0.45	20	0.78	0.38	0.43	30	1.93	0.41	0.48
	50	14.5	0.41	0.38	0.43	21	0.83	0.36	0.41	30	2.04	0.44	0.50
55	15.0	0.43	0.37	0.43	21	0.85	0.37	0.43	30	2.13	0.46	0.53	
90°	25	-	-	-	-	17	0.31	0.41	0.48	25	0.69	0.43	0.51
	30	12.0	0.16	0.43	0.50	18	0.33	0.39	0.45	27	0.74	0.39	0.48
	35	13.0	0.18	0.40	0.46	19	0.37	0.39	0.46	28	0.80	0.39	0.48
	40	13.5	0.19	0.39	0.45	20	0.40	0.39	0.44	30	0.86	0.37	0.45
	45	14.0	0.20	0.39	0.45	21	0.42	0.37	0.42	30	0.91	0.39	0.48
	50	14.5	0.21	0.38	0.43	22	0.44	0.35	0.40	30	0.96	0.41	0.50
55	15.0	0.22	0.37	0.43	22	0.47	0.37	0.43	30	1.01	0.43	0.53	

■ \*PRECIP IN/H

▲ \*PRECIP IN/H



## Hunter Valves

Control valves are the heart of your irrigation system. Hunter has assembled one of the broadest line-ups in the industry.



PDPGV100G



PDPGV151



PDICV151G



Accu-Sync INSTALLED ON ICV



Latching Solenoid

## PGV Valves

### PGV Series:

- High grade construction, 150 PSI rating
- Internal manual bleed
- Flow control with non-rising handle
- Rigid diaphragm support
- Globe and angle configurations
- Accu-Sync™ pressure regulator compatible



PGV SERIES		CASE QTY.	PRICE
PDPGV100G	1" plastic, FIPT x FIPT	20	\$ 44.40
PDPGV100MB	1" plastic, MIPT x Barb	20	\$ 44.40
PDPGV101G	1" plastic, FIPT x FIPT, flow-control	20	\$ 50.88
PDPGV151	1½" plastic, FIPT x FIPT, flow-control	8	\$ 204.44
PDPGV201	2" plastic, FIPT x FIPT, flow-control	8	\$ 294.26
PDP332100	Diaphragm assembly 1" standard	1	\$ 18.16
PDP414100	Diaphragm assembly 1.5" PGV	1	\$ 30.25
PDP415600	Diaphragm assembly 2" PGV	1	\$ 43.39

## ICV Valves

### ICV Series - Commercial:

- Glass-filled nylon construction, 220 PSI rated
- Internal manual bleed
- Captive solenoid plunger
- Captive bonnet bolts with matching brass body inserts
- Fabric reinforced diaphragm
- Filter-Sentry™ optional for dirty water
- Optional Accu-Sync™ pressure regulator



ICV SERIES		CASE QTY.	PRICE
PDICV151G	1½" plastic, FIPT x FIPT, globe	8	\$ 325.25
PDICV151GFS	1½" plastic, FIPT x FIPT, filter-sentry, globe	8	\$ 464.65
PDICV201G	2" plastic, FIPT x FIPT, globe	8	\$ 443.98
PDICV201GFS	2" plastic, FIPT x FIPT, filter-sentry, globe	8	\$ 567.90
PDICV301FS	3" plastic, FIPT x FIPT, filter-sentry, globe	8	\$ 1,161.58

## Pressure Regulator

Accu-Sync PRESSURE REGULATOR - FITS ALL HUNTER VALVES	CASE QTY.	PRICE
PDACCUSYNCADJ	Adjustable pressure regulator	1 \$ 191.04

**Fixed pressure regulating device available as special order upon request**

## Solenoid

HUNTER REPLACEMENT SOLENOID FITS ALL HUNTER VALVES	PRICE
PDP606800	Hunter Solenoid \$ 22.20
PDP458200	DC Latching Solenoid \$ 55.79

# Hunter®

www.hunterindustries.com



PGP • 3/4" FIPT

## PGP® Rotor Sprinkler

The worlds best selling 3/4" rotor.

### Features:

- 4" pop-up height
- Integral rubber cover
- Complete set of 12 nozzles
- Low angle nozzle set available
- Blue nozzles available PLEASE SPECIFY WHEN ORDERING
- PGP-ATR available - a PGP internal replacement for older model impact rotors.

PGP ROTORS		CASE QTY.	PRICE
PDPGPADJ	4" Part/Full Circle	20	\$ 29.94
PDPGP12CV	12" Part/Full Circle	12	\$ 84.16



PGP-ULTRA • 3/4" FIPT

## PGP® Ultra

### Features:

- Easy arc adjustment (50° - 360°): Full and part-circle operation in a single rotor
- Automatic arc return: returns to the original arc regardless of where the turret is turned
- Non-strippable, vandal-proof drive mechanism enables the turret to be turned without causing damage
- Headed and slotted nozzle retainer screw. Easy to use, easy to clean

PGP ULTRA ROTORS		CASE QTY.	PRICE
PDPGP04	4" Part/Full Circle	20	\$ 29.94
PDPGP04CHECK	4" Part/Full Circle w/Check Valve	20	\$ 29.94
PDPGP-0420CHECK	4" Part/Full Circle w/Check Valve 2.0 Nozzle	20	\$ 29.94



I-20 • 3/4" FIPT

## I-20 Rotor Sprinkler

### Features:

- Integral rubber cover
- Flo-Stop Control, manual individual stop
- Easy arc adjustment (40° - 360°)
- Heavy-duty retractable spring
- Stainless steel option
- Blue nozzles available
- 5 year warranty
- Drain check valve and extra strong spring

I-20 ROTORS		CASE QTY.	PRICE
PDI2004	4" P/F check valve	20	\$ 46.46
PDI2004SS	4" P/F C/V stainless	20	\$ 66.84



### STANDARD ANGLE NOZZLE SET - PGP

PRESSURE PSI	NOZZLE	RADIUS FT.	FLOW GPM	PRECIP IN/HR	PRECIP IN/HR	
30	1	28	0.5	0.12	0.14	
	2	29	0.7	0.16	0.19	
	3	30	0.9	0.19	0.22	
	4	32	1.2	0.23	0.26	
	5	34	1.6	0.27	0.31	
	6	34	2.0	0.33	0.38	
	7	34	2.6	0.43	0.50	
	8	37	3.2	0.45	0.582	
	9	38	3.6	0.48	0.55	
	40	1	29	0.6	0.14	0.16
		2	30	0.8	0.17	0.20
		3	31	1.0	0.20	0.23
4		33	1.4	0.25	0.29	
5		36	1.8	0.27	0.31	
6		36	2.4	0.36	0.41	
7		38	3.0	0.40	0.46	
8		39	3.7	0.47	0.54	
9		39	4.3	0.49	0.57	
10		46	6.8	0.62	0.71	
11		48	8.9	0.74	0.86	
12		48	11.9	0.99	1.15	
50	1	29	0.7	0.16	0.19	
	2	30	0.9	0.19	0.22	
	3	31	1.2	0.24	0.28	
	4	34	1.6	0.27	0.31	
	5	38	2.0	0.27	0.31	
	6	38	2.7	0.36	0.42	
	7	40	3.4	0.41	0.47	
	8	41	3.9	0.45	0.52	
	9	44	5.2	0.52	0.60	
	10	47	7.6	0.66	0.76	
	11	50	9.8	0.75	0.87	
	12	50	12.7	0.98	1.13	
60	1	30	0.8	0.17	0.20	
	2	31	1.0	0.20	0.23	
	3	32	1.3	0.24	0.28	
	4	34	1.8	0.30	0.35	
	5	38	2.2	0.29	0.34	
	6	38	2.9	0.39	0.45	
	7	40	3.7	0.45	0.51	
	8	42	4.6	0.50	0.58	
	9	45	5.5	0.55	0.60	
	10	49	8.2	0.66	0.76	
	11	51	10.5	0.78	0.90	
	12	52	14.1	1.00	1.16	

### STANDARD ANGLE NOZZLE SET - I-20 & PGP Ultra

PRESSURE PSI	NOZZLE	RADIUS FT.	FLOW GPM	PRECIP IN/HR	PRECIP IN/HR
30	1.0	30	0.9	0.19	0.22
	1.5	32	1.2	0.23	0.26
	2.0	32	1.6	0.30	0.35
	3.0	34	2.0	0.33	0.38
	3.5	34	2.6	0.43	0.52
	4.0	37	3.2	0.45	0.52
	6.0	35	4.2	0.66	0.76
	2.0LA	25	1.6	0.49	0.57
	2.5LA	27	2.1	0.55	0.64
	3.5LA	29	2.8	0.64	0.74
	4.5LA	29	3.4	0.78	0.90
	40	1.0	31	1.0	0.20
1.5		33	1.4	0.25	0.29
2.0		34	1.8	0.30	0.35
3.0		36	2.4	0.36	0.41
3.5		38	3.0	0.40	0.46
4.0		39	3.7	0.47	0.54
6.0		40	4.9	0.59	0.68
8.0		44	6.8	0.68	0.78
2.0LA		27	1.9	0.50	0.58
2.5LA		30	2.5	0.53	0.62
3.5LA		32	3.1	0.58	0.67
4.5LA		32	3.9	0.73	0.85
50	1.0	31	1.2	0.24	0.28
	1.5	34	1.6	0.27	0.31
	2.0	36	2.0	0.30	0.34
	3.0	38	2.7	0.36	0.42
	3.5	40	3.4	0.41	0.47
	4.0	41	4.2	0.48	0.56
	6.0	43	5.5	0.57	0.66
	8.0	45	7.6	0.72	0.83
	2.0LA	28	2.1	0.52	0.60
	2.5LA	33	2.8	0.49	0.57
	3.5LA	35	3.5	0.55	0.64
	4.5LA	35	4.4	0.69	0.80
60	1.0	32	1.3	0.24	0.28
	1.5	34	1.8	0.30	0.35
	2.0	36	2.2	0.33	0.38
	3.0	38	2.9	0.39	0.45
	3.5	40	3.7	0.45	0.51
	4.0	42	4.6	0.50	0.58
	6.0	44	6.0	0.60	0.69
	8.0	47	8.2	0.71	0.83

Precipitation rates based on half circle throw





I-25 • 1" FIPT

## I-25 Rotor Sprinkler

Efficient, economical, easy to use. The ideal choice for commercial and recreational sites.

### Features:

- New non-strippable vandal-proof drive
- 5 colour-coded nozzles supplied
- Easy arc adjustment (50° - 360°)
- Drain check valve
- Full and part circle in one
- Automatic arc return



I-25 ROTORS		CASE QTY.	PRICE
PDI2504	3.5" P/F Circle	12	\$ 113.58
PDI2504SS	3.5" P/F Circle, Stainless Steel	12	\$ 144.55

### I-25 NOZZLE SET (MORE AVAILABLE)

PRESSURE PSI	NOZZLE	RADIUS FT.	FLOW GPM	PRECIP IN/HR	PRECIP IN/HR
50	7 ORG	47	7.0	0.61	0.70
	10 LT.GRN	51	10.1	0.75	0.86
	13 LT.BLU	53	11.2	0.77	0.89
	15 GRY	56	13.4	0.82	0.95
	20 DK.BRN	-	-	-	-
60	7 ORG	48	7.5	0.63	0.72
	10 LT.GRN	52	11.1	0.79	0.91
	13 LT.BLU	54	12.3	0.81	0.94
	15 GRY	57	14.3	0.85	0.98
	20 DK.BRN	62	17.8	0.89	1.03
70	25 DK.BLU	66	23.5	1.04	1.20
	7 ORG	49	7.9	0.63	0.73
	10 LT.GRN	53	12.1	0.83	0.96
	13 LT.BLU	55	13.3	0.85	0.98
	15 GRY	57	15.2	0.90	1.04
80	20 DK.BRN	63	19.2	0.93	1.08
	25 DK.BLU	68	25.5	1.06	1.23
	7 ORG	-	-	-	-
	10 LT.GRN	54	12.9	0.85	0.98
	13 LT.BLU	55	14.3	0.91	1.05
	15 GRY	58	16.4	0.94	1.08
	20 DK.BRN	64	20.5	0.96	1.11
	25 DK.BLU	69	28	1.13	1.31

■ \*PRECIP IN/HR

▲ \*PRECIP IN/HR



I-40 • 1" FIPT

## I-40 Rotor Sprinkler

The top choice at sports facilities worldwide, a winner for parks and commercial sites as well

### Features:

- Non-strippable drive
- Uniform coverage with radius from 45 to 74 feet
- Stainless steel riser and super-strong spring
- Drain check valve for up to 15 feet elevation change
- Full and part circle in one
- Auto arc return



I-40 ROTOR		CASE QTY.	PRICE
PDI4004SS	4" P/F Circle, Stainless Steel, CV	12	\$ 221.99

### I-40 NOZZLE SET

PRESSURE PSI	NOZZLE	RADIUS FT.	FLOW GPM	PRECIP IN/HR	PRECIP IN/HR
60	41	51	11.1	0.82	0.95
	42	53	12.3	0.84	0.97
	43	57	15.1	0.89	1.02
	44	63	20.0	0.97	1.12
	45	66	22.7	1.00	1.16
70	41	52	12.1	0.86	0.99
	42	55	13.1	0.83	0.96
	43	59	16.1	0.89	1.03
80	44	65	21.8	0.99	1.15
	45	68	24.7	1.03	1.19
	41	53	13.0	0.89	1.03
	42	56	13.9	0.85	0.99
	43	61	17.5	0.91	1.05
	44	66	23.4	1.03	1.19
	45	69	26.4	1.07	1.23

Precipitation rates based on half circle throw

■ \*PRECIP IN/HR

▲ \*PRECIP IN/HR



I-50 • 1" FIPT

## I-50 Rotor Sprinkler

This large turf rotor is built to conquer the most demanding conditions. The powerful internal drive mechanism and versatile arc adjustment style are derived from Hunter's time-proven golf rotors, so you can ensure top performance in any application.

### Features:

- Extra strong, non-strippable drive
- Uniform coverage with radius from 44 to 69 feet
- Stainless steel riser for extra durability
- Drain check valve for prevention of low-head drainage up to 15 feet elevation change
- Recommended pressure range of 40-100 psi



I-50 ROTOR		CASE QTY.	PRICE
PDI5006SS	6" Stainless Steel, adjustable, CV	12	\$ 293.23

### I-50 NOZZLE SET

PRESSURE PSI	NOZZLE	RADIUS FT.	FLOW GPM	PRECIP IN/HR	PRECIP IN/HR
60	41	50	11.3	0.87	1.00
	42	51	12.3	0.91	1.05
	43	55	15.7	1.00	1.15
	44	62	21.3	1.07	1.23
	45	66	23.9	1.06	1.22
70	41	51	12.2	0.90	1.04
	42	52	13.3	0.95	1.08
	43	57	16.6	0.98	1.14
	44	64	23.0	1.08	1.25
	45	67	25.8	1.11	1.28
80	41	51	13.0	0.96	1.11
	42	53	14.2	0.97	1.12
	43	59	18.3	1.01	1.17
	44	65	24.5	1.12	1.29
	45	68	27.7	1.15	1.33

Precipitation rates based on half circle throw

■ \*PRECIP IN/HR

▲ \*PRECIP IN/HR

# Hunter®

www.hunterindustries.com



I-90 • 1/2" INLET

## I-90 Rotor Sprinkler

Hunter's longest distance rotary sprinkler specifically designed for natural turf, parks, sports fields and public areas.

### Features:

- Opposing nozzle 360° model
- dual trajectory colour-coded nozzles
- optional reclaimed water ID
- Drain check valve up to 9' of elevation



I-90 ROTORS		CASE QTY.	PRICE
PD190ADV	3" Pop up, adjustable arc	12	\$ 397.52

### 190 NOZZLE SET (MORE AVAILABLE)

PRESSURE PSI	NOZZLE	RADIUS FT.	FLOW GPM	■ PRECIP IN/HR	▲ PRECIP IN/HR
80	25 LT. BLUE	66	29.5	1.30	1.51
	33 GRAY	68	36.2	1.51	1.74
	38 RED	72	40.6	1.51	1.74
	43 DK. BROWN	74	46.1	1.62	1.87
	48 DK GREEN	77	50.2	1.63	1.88
	53 DK BLUE	81	54.9	1.61	1.86
90	63 BLACK	86	62.3	1.62	1.87
	73 ORANGE	89	72.7	1.77	2.04
	25 LT. BLUE	67	31.5	1.35	1.56
	33 GRAY	69	38.2	1.54	1.78
	38 RED	73	43.0	1.55	1.79
	43 DK. BROWN	74	48.5	1.70	1.97
100	48 DK GREEN	79	52.6	1.62	1.87
	53 DK BLUE	84	57.2	1.56	1.80
	63 BLACK	88	65.5	1.63	1.88
	73 ORANGE	91	75.4	1.75	2.02
	25 LT. BLUE	68	33.2	1.38	1.60
	33 GRAY	70	40.4	1.59	1.83
	38 RED	75	45.4	1.55	1.79
	43 DK. BROWN	75	50.7	1.74	2.00
48 DK GREEN	81	55.1	1.62	1.87	
53 DK BLUE	86	59.5	1.55	1.79	
63 BLACK	90	69.0	1.64	1.89	
73 ORANGE	93	78.1	1.74	2.01	

■ \*PRECIP IN/HR  
▲ \*PRECIP IN/HR



PDSTG-900

## STG-900 Rotor Sprinkler

The Hunter ST System is the first and only cost-effective, fully integrated solution designed to exceed the unique and specific needs of the synthetic turf irrigation market. This model includes through-the-top access to the riser assembly. The STG-900 is ideally suited for installation within the ST vault that is installed under the synthetic surface. It can also be installed in the natural turf that is sometimes adjacent to the synthetic field to be irrigated.

### Features:

- Standard installed nozzle #83
- Arc adjustment: Through the top
- Arc setting: 40 - 360 degrees
- Factory installed rubber logo cap
- Nozzle trajectory: 22.5°



STG-900 ROTOR		CASE QTY.	PRICE
PDSTG900	Adjustable 1/2" inlet ACME	4	\$ 811.55

### STG-900 NOZZLE SET

PRESSURE PSI	NOZZLE	RADIUS FT.	FLOW GPM	■ PRECIP IN/HR	▲ PRECIP IN/HR
101	73 Orange	103	74.4	1.35	1.56
	83 Tan	112	84.1	1.29	1.49
108	73 Orange	109	77.0	1.24	1.44
	83 Tan	116	88.0	1.26	1.46
116	73 Orange	115	79.6	1.15	1.34
	83 Tan	120	92.0	1.23	1.42

■ \*PRECIP IN/HR  
▲ \*PRECIP IN/HR

## ST-1600 System

*A unique package of irrigation products designed to clean, cool and prepare synthetic turf sports fields for play.*

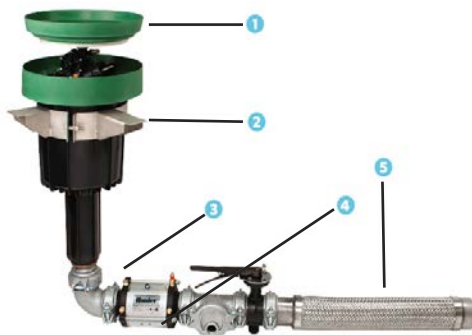

1. ST Infill Barrier System
2. ST Adjustable Hanger Bracket
3. ST Manifold & Isolation Valve
4. ST Low-Loss, Slow Opening Valve
5. ST Flexible Stainless Inlet Hose

The ST System features total top access to all irrigation components making maintenance simple while keeping the surface intact, playable and safe. The exclusive Infill Barrier System (IBS) accommodates every field surface configuration including infill turf, short non-infill turf, synthetic running track, and in-concrete installations. The robust and reliable manifold features 80 mm galvanized ductile iron components with heavy-duty grooved (Victaulic™ type) fittings. Also included is a slow-opening, low pressure loss control valve, isolation valve, drain valve, quick coupler valve, and the powerful ST-1600B long-range gear-driven rotor.



# WiFi Compatible Controllers



## PRO-HC Controller

Professional Grade Wi-Fi Controller with Hydrawise Web-based Software

- Dedicated master valve/pump start
- Large wiring compartment
- Flow sensing ability
- Wifi Enabled



PRO-HC CONTROLLERS		CASE QTY.	PRICE
PDPHC600I	6 Station Indoor Wifi Controller	8	\$ 632.92
PDPHC600	6 Station Outdoor Controller	8	\$ 664.93
PDPHC1200I	12 Station Indoor Wifi Controller	8	\$ 792.96
PDPHC1200	12 Station Outdoor Controller	8	\$ 834.26
PDPHC2400I	24 Station Indoor Controller	8	\$ 1,409.36
PDPHC2400	24 Station Outdoor Controller	8	\$ 1,435.21

## X Core

Entry-level residential controller with extra flexibility, features and memory.



PDXC600

XC CONTROLLERS		CASE QTY.	PRICE
PDXC200I	2 Station - Indoor	10	\$ 201.34
PDXC400I	4 Station - Indoor	10	\$ 222.00
PDXC400	4 Station - Outdoor	10	\$ 251.13
PDXC600I	6 Station - Indoor	10	\$ 258.13
PDXC600	6 Station - Outdoor	10	\$ 281.77
PDXC800I	8 Station - Indoor	10	\$ 330.43
PDXC800	8 Station - Outdoor	10	\$ 337.20
PDROAMWH	Smart port wiring harness	1	\$ 28.91

Smart Port Connectors no longer supplied with controller  
Available while quantities last



## X2 Wifi Controller

The X2 controller continues the legacy set by the popular X-Core® with a similar set of reliable and highly efficient capabilities, but brings irrigation management into the next generation by providing the option to add Wi-Fi for remote management and advanced water-saving features using Hunter's industry-leading Hydrawise® software.



X2 Wifi Controller

X-CORE WIFI CONTROLLERS		CASE QTY.	PRICE
PDX2-400	4 Station Wifi Indoor/Outdoor Controller with Pigtail	10	\$ 245.74
PDX2-600	6 Station Wifi Indoor/Outdoor Controller with Pigtail	10	\$ 281.87
PDX2-800	8 Station Wifi Indoor/Outdoor Controller with Pigtail	10	\$ 336.60
PDX2-1400	14 Station Wifi Indoor/Outdoor Controller with Pigtail	10	\$ 582.33
PDWAND	Module Wifi for x2 Controllers	10	\$ 276.71



PDPC400



## Pro-C Controllers

PRO-C MODULAR CONTROLLERS		CASE QTY.	PRICE
PDHPC400	4-16 Stations - Outdoor - Modular with Wifi	8	\$ 491.04
PDPC400I	4 Station - Indoor - Modular	8	\$ 351.07
PDPC400	4 Station - Outdoor - Modular	8	\$ 413.01
PDPCM300	3 Station Module	12	\$ 118.76
PDPCM900	9 Station Module	12	\$ 423.35

PRO-C CONVENTIONAL CONTROLLERS		CASE QTY.	PRICE
PDPC600I	6 Station Indoor Conventional	8	\$ 335.56
PDPC1200I	12 Station Indoor Conventional	8	\$ 451.68
PDHPC-FP	PRO-C Face Panel, Wifi Compatible	10	\$ 438.81

HPC Face Panel allows any PRO-C manufactured since March 2014 to access Hydrowise software



HCC Controller

## HCC Controllers

The next generation HCC Controller combines the robust features of the ICC2 controller with automatic, weather-based daily adjustments of Hydrowise programming to create a smart and economical solution for commercial landscape management.

HCC CONTROLLERS		PRICE
PDHCC800M	8 Station Metal Wi-Fi Controller - up to 54 stations	\$ 1,857.47
PDHCC800PL	8 Station Plastic Wi-Fi Controller - up to 38 stations	\$ 1,196.67



ACC Controller

## ACC2 and ACC2 Decoder Controllers

Hunter's most powerful controller for command of large and sophisticated sites.

ACC CONTROLLERS		PRICE
PDA2C1200M	12 Station Base Unit	\$ 2,729.63
PDA2M600	6 Station Expansion Module	\$ 809.90
PDACC99D	ACC Decoder Controller	\$ 5,758.79
PDADM99	Decoder Module for ACC	\$ 2,593.14



ICC2 Controller

## ICC2 Commercial Controller

ICC2 is a value-packed, light-to-mid size commercial irrigation controller that delivers more than you expect, just like its famous predecessor. It is designed to control larger projects (up to 54 stations) and offers the water savings you expect from a Hunter controller.

- 8 to 54 Stations (metal)
- 8 to 38 Stations (plastic)
- Modular
- 4 Independent programs
- Prewired for Hunter ROAM and ROAM XL

ICC2 CONTROLLERS		CASE QTY.	PRICE
PDI2C800PL	8 Station Commercial Controller	4	\$ 758.89
PDICM400	4 Station Expansion Module	20	\$ 227.15
PDICM800	8 Station Expansion Module	20	\$ 397.51
PDICM2200	22 Station Expansion Module	1	\$ 800.19





# Landscape Irrigation Products

**Hunter**<sup>®</sup>  
www.hunterindustries.com



PDICD-100, 200, 400,  
600 & ICD-SEN



PDEZ-1 Single  
Station Decoder



PDEZ-DM Decoder Output  
Module

HUNTER DECODERS		PRICE
PDEZDM	Decoder output module for HCC and ICC2 Controllers	\$ 567.89
PDPC-DM	Decoder output module for Pro-C Controllers	\$ 454.37
PDEZ1	Single Station decoder with status LED	\$ 163.14
PDICD100	Single Station Decoder- For ACC Decoder Controller	\$ 361.38
PDICD200	Double Station Decoder- For ACC Decoder Controller	\$ 593.69
PDICD400	4 Station Decoder- For ACC Decoder Controller	\$ 965.41
PDICD600	6 Station Decoder- For ACC Decoder Controller	\$ 1,058.34

**NEW**

For Decoder Wire Connections, see pg. 72.



Pump Start Relay

## Pump Start Relay

PUMP START RELAY		PRICE
PDPSR22	120V up to 2hp or 240V up to 3.5hp	\$ 201.35
PDPSR52	120V up to 5hp or 240V up to 7.5hp	\$ 314.91
PDPSR53	3 phase, up to 10hp	\$ 567.88



HC Flow Meters

## Hunter/Hydrawise Flow Meters

PART #	SIZE	MIN. FLOW (GPM)	CONNECTIONS	CASE QTY.	PRICE
PDHC075FLOW	3/4"	0.22	NPT	1	\$ 352.08
PDHC100FLOW	1"	0.3	NPT	1	\$ 394.42
PDHC150FLOW	1 1/2"	0.88	NPT	1	\$ 838.91
PDHC200FLOW	2"	1.98	NPT	1	\$ 1,120.96

Netafim compatible options on Pg. 46

Hydrawise cloud software is a user-friendly water management software. It is a powerful tool for professional contractors that provide in-depth water management capabilities for their clients' landscapes, piping systems and electrical systems.

### User Features:

- Remote access
- Predictive watering adjustments
- Extensive system reporting keeps you in the know
- Monitor internet connection, flow, and electrical current
- Smartphone and web access
- Troubleshooting notifications via text and app

### Contractor Features:

- Contractor Management System allows access to multiple controllers at a time
- Contractor dashboard
- Staff access management
- Store irrigation plans
- Advanced reporting
- Controller change logs

Maximum Controllers: Unlimited  
Platform: Computer and mobile devices  
Type: Water Management





## Node BT Valve Controller

NODE-BT is enabled with powerful wireless Bluetooth® technology that can be easily managed from a smartphone.

- Bluetooth control from up to 50' away
- One smartphone manages unlimited number of controllers
- Available in 1, 2 and 4 station models

NODE BT CONTROLLER		PRICE
PDNODE-BT-100	1 station, includes latching solenoid	\$ 328.03
PDNODE-BT-200	2 stations, solenoids not included	\$ 472.09
PDNODE-BT-400	4 stations, solenoids not included	\$ 573.88



## 9V Battery Operated Controller

- Fits all Hunter plastic valves
- 9 start times
- Available in 1, 2, 4 and 6 station models

NODE BATTERY OPERATED CONTROLLERS		PRICE
PDNODE1	1 station, includes latching solenoid	\$ 330.41
PDNODE2	2 station, solenoids not included	\$ 474.97
PDNODE4	4 station, solenoids not included	\$ 578.21
PDNODE6	6 station, solenoids not included	\$ 609.18
PDP458200	Latching solenoid - parts discount applicable	\$ 55.79
PDSPNODE	Solar Panel for NODE Controller	\$ 376.86



Latching Solenoid

SOLENOID		PRICE
PDP458200	Latching solenoid - parts discount applicable	\$ 55.79



BTT

## BTT

Bluetooth enabled battery operated tap timer controlled via smartphone.

BTT TAP TIMER		PRICE
PDBTT100	Controller Bluetooth Tap Timer	\$ 144.56
PDBTT-200	Controller Bluetooth Tap 2 Zone	\$ 218.89



Roam Remote & Receiver

Roam XL Remote & Receiver

## ROAM XL

Residential Remote Systems:

- Mid-range solution for residential & commercial
- 128 different programmable addresses
- Range of 1000 feet
- Compatible with Hunter ICC, ProC, SRC & ACC through smart port connection



REMOTE SYSTEMS		PRICE
PDROAM	Residential Remote Complete Kit - 2 year warranty	\$ 573.04
PDROAMXL	Commercial Remote kit, includes case	\$ 1,806.89
PDROAMSCWH	Smart port harness with 25' shielded cable	\$ 42.34
PDROAMWH	Smart port wiring harness	\$ 28.91

Roam XL receiver sold separately upon request.



WIRELESS RAIN CLIK

## Weather Sensors

OUTWIT THE WEATHER. No matter what the weather forecast may say, Hunter sensors are ready for any weather at any time. The entire lineup offers a level of additional protection unmatched in the industry. No matter rain, ice, wind, or sun, a Hunter sensor is ready for it all.



SOLAR SYNC AND SENSOR KIT

HUNTER SENSORS		PRICE
PDMINICLIK	Standard rain sensor	\$ 78.50
PDRAINCLIK	Instant shut-off	\$ 78.47
PDWRCLIK	Rain/Freeze Sensor	\$ 221.99
PDMINICLIKNO	Normally open rain sensor	\$ 92.96
PDWSS	Wireless Solar Sync Kit	\$ 464.64





# Online Training Portal



Irrigation Association Certified  
Water Smart Irrigation Professional Certified  
On-Board new or seasonal employees  
Learn potential new services like Landscape Lighting or Drainage  
Effective use of time on bad weather days





# Online Training Portal

## Back Flow Prevention

- Backflow Prevention in Irrigation Systems
- Winterizing an Irrigation System

## Business

- HindSite Software
- Customer Focused Sales
- Service Matters
- Preparing the Annual Budget
- Direct Costs
- G&A Overhead Costs
- Calculating Labour Burden
- Calculating Field Labour Payroll
- Equipment Costs
- Equipment Exercises
- Calculating Daily Rate for Crews
- Crew Leader: Managing the Project
- Crew Leader: How to Lead and Motivate
- Crew Leader: Organization, Time and Cost
- Crew Leader: Planning & Scheduling
- Local Search: Why? How? What to Expect?
- Quickbooks Intro for Beginners Part 1
- The Basics of Excel
- The Extended Marketing Mix

## Drainage

- Opportunity & Overview of Drainage
- Introduction to Landscape Drainage
- Designing a Landscape Drainage System
- How to Sell Drainage
- Bidding & Estimating Drainage
- Growing Sales of Drainage Products
- Installing a Landscape Drainage System: Residential
- How to Install Drainage
- Corrugated Drainage Products
- Presenting & Selling a Landscape Drainage System

## Pumps

- Pump 101 - Intro to Pumps & Total Dynamic Head
- Selecting and Sizing Irrigation Pumps
- Understanding & Specifying a VFD

## Drip Irrigation

- Drip Irrigation Principals, Practices & Products
- In-Line Drip Irrigation: Planning & Installing
- Point-Source Drip Irrigation

## Electrical

- Basic Electrical Knowledge & Troubleshooting
- Use of Wire Tracking & Fault Finding Equipment
- Troubleshooting & Solving Decoder-Based Irrigation System Problems
- Solving Electrical Problems with an Irrigation Valve
- Grounding Techniques for Two Wire Decoder Irrigation Systems
- Proper Wire Splicing for Two Wire Decoder Irrigation Systems

## Irrigation

- Proper Solvent Cementing Techniques for PVC Pipe
- Irrigation Troubleshooting Introduction
- Design a Professional Irrigation Job
- Presenting & Selling a Professional Irrigation Job
- Installing a Professional Irrigation Job
- Rid-O-Rust Products & Applications: Introduction Chemigation
- Making Waterproof Splices for Irrigation Systems
- Troubleshoot a Residential Irrigation System
- How to Install an Add-A-Zone
- Working Around a Broken Wire or a Bad Splice
- Adding a New Zone to an Existing Irrigation System with the Add-A-Zone
- How to Operate a Split Zone Due to Low Pressure with the Add-a-Zone

## Landscape Lighting

- Landscape Lighting Opportunity & Overview
- Introduction to Landscape Lighting
- Designing Part 1 - Creating the Design
- Designing Part 2 - Specifying Fixtures & Drawing a Plan
- How to Design Landscape Lighting
- Bidding & Estimating Landscape Lighting
- Presenting & Selling Landscape Lighting
- Selling LED Lighting with Confidence
- Installing Landscape Lighting





## Swing Pipe, Saddles & Fittings



### DAWN KWIK-SEAL SADDLES

PART #	SIZE	BAG QTY.	BOX QTY.	PRICE EACH
FLSADP755	3/4" x 1/2" (GREY)	10	250	\$ 4.49
FLSADP7575	3/4" x 3/4" (GREY)	10	250	\$ 4.72
FLSADP15	1" x 1/2" (WHITE)	10	250	\$ 4.76
FLSADP175	1" x 3/4" (WHITE)	10	250	\$ 5.11
FLSADP125	1 1/4" x 1/2" (WHITE)	10	250	\$ 7.23
FLSADP1275	1 1/4" x 3/4" (WHITE)	10	250	\$ 7.55
FLND375	Plastic saddle nut driver	N/A	N/A	\$ 7.33
FLHCC	3/4" & 1/2" pipe coring tool	N/A	N/A	\$ 33.62



### DAWN KWIK-TAP SADDLES

PART #	SIZE	BAG QTY.	BOX QTY.	PRICE EACH
FLKT755	3/4" x 1/2" (ORANGE)	10	200	\$ 5.84
FLKT7575	3/4" x 3/4" (ORANGE)	10	200	\$ 5.84
FLKT15	1" x 1/2" (ORANGE)	10	200	\$ 5.94
FLKT175	1" x 3/4" (ORANGE)	10	200	\$ 5.94
FLKT125	1 1/4" x 1/2" (ORANGE)	10	200	\$ 9.47
FLKT1275	1 1/4" x 3/4" (ORANGE)	10	200	\$ 9.47
FLKT155	1 1/2" x 1/2" (ORANGE)	10	200	\$ 11.42
FLKT1575	1 1/2" x 3/4" (ORANGE)	10	200	\$ 11.42



### RAIN BIRD SWING PIPE & FITTINGS

PART #	SIZE	BAG QTY.	BOX QTY.	PRICE
AXSB-CPLG	Swing pipe coupler	50	200	\$ 0.84
AXSBE-050	1/2" MIPT x swing pipe elbow	50	200	\$ 0.57
AXSBE-075	3/4" MIPT x swing pipe elbow	50	200	\$ 0.63
AXSB-TEE	Swing pipe tee	50	200	\$ 1.12
AXSP100F	Rain Bird swing pipe, extra flex/grip (100')	N/A	N/A	\$ 77.12



### LASCO SWING PIPE FITTINGS

PART #	SIZE	BAG QTY.	BOX QTY.	PRICE
BASBE-050	1/2" MIPT x swing pipe elbow	25	500	\$ 0.69
BASBE-075	3/4" MIPT x swing pipe elbow	25	500	\$ 0.69
BASBA-050	1/2" MIPT x swing pipe male adapter	25	100	\$ 2.07
BASBA-075	3/4" MIPT x swing pipe male adapter	25	100	\$ 1.24
BASB-TEE	Swing pipe tee	25	100	\$ 3.76
BASB-COUP	Swing pipe coupling	25	100	\$ 0.88

**HYDRO-RAIN®**



Hydro-Rain's manifold system reduces sprinkler valve manifold fabrication time by 44%.

- Glue-Less, Built in "Wrench Tight" feature
- Oversized O-ring and Union Prevent Leaks

PART #	DESCRIPTION	BAG/BOX QTY.	HYDRO-RAIN #	PRICE
ORHRM1	One Valve Manifold	5/30	03100	\$ 7.16
ORHRM2	Two Valve Manifold	5/30	03108	\$ 14.30
ORHRM3	Three Valve Manifold	5/25	03101	\$ 19.35
ORHRM-CAP	Manifold Cap	5/200	03102	\$ 7.16
ORHRM-COUP	Manifold Coupler	5/100	03110	\$ 9.56
ORHRM-FA1	Female Adapter x FIPT	5/100	03107	\$ 9.01
ORHRM-MA1+	Manifold Swivel x 1" MPT	5/100	03104	\$ 7.16

PART #	DESCRIPTION	QTY.	PRICE
OR08685	1" Push x Spigot x MIPT Manifold Tee	20 pack	\$ 13.25
OR08688	1" Push x Spigot x FIPT Manifold Tee	20 pack	\$ 13.25
OR08681	1" Push x FIPT Manifold Elbow	10 pack	\$ 6.63
OR08679	1" Push x MIPT Manifold Elbow	10 pack	\$ 7.69

**HYDRO-RAIN®**

*Built for Speed®*

THE FUTURE OF IRRIGATION HAS ARRIVED

**Blu-Lock® & PVC-Lock®**

**3X  
FASTER**



**NO GLUE**



**NO TOOLS**



**NO TORCHES**

Learn more at:

**HYDRORAIN.COM/PUSHFITTINGS**



**INCREASE SPEED > INCREASE PROFITS**



## Swing Pipe, Saddles & Fittings



PART #	SIZE	BAG QTY.	CASE QTY.	PRICE
OR37970	1/2" MIPT x swing pipe elbow	25	500	\$ 1.59
OR37971	3/4" MIPT x swing pipe elbow	25	500	\$ 1.59
OR37974	1/2" MIPT x swing pipe male adapter	25	250	\$ 1.66
OR37975	3/4" MIPT x swing pipe male adapter	25	500	\$ 1.66
OR37976	Swing pipe coupling	25	500	\$ 2.81
OR37977	Swing pipe tee	25	300	\$ 4.24
OR37979	Swing Pipe Elbow 1/2"	25	500	\$ 1.96
OR37985	Swing Joint 1/2" x 1/2" MIPT	25	250	\$ 2.65
OR37986	Swing Joint 1/2" x 3/4" MIPT	25	250	\$ 2.65
OR37987	Blu-Lock Elbow 1/2" x 1/2"	25	500	\$ 2.39
OR37900	Swing pipe x Blu-Lock coupling	25	500	\$ 2.51
OR02916	Saddle for 3/4" pipe (for use with OR2918 or OR2919)	25	250	\$ 2.65
OR02917	Saddle for 1" pipe (for use with OR2918 or OR2919)	25	250	\$ 2.65
OR02918	Saddle adapter x 1/2" Blu-Lock	25	250	\$ 2.65
OR02919	Saddle adapter x 1/2" MIPT	25	250	\$ 2.67
ORBSP100	1/2" Blu-lock Pipe (100')	N/A	N/A	\$ 68.90

## Blu-Lock Fittings



PART#	DESCRIPTION	BAG QTY.	CASE QTY.	PRICE
OR37370	3/4" Blu-Lock Tee	10	100	\$ 4.78
OR37373	3/4" x 1/2" Blu-Lock Reducing Tee	10	100	\$ 4.78
OR37670	1" Blu-Lock Tee	10	50	\$ 6.13
OR37672	1" x 1/2" Blu-Lock Reducing Tee	10	50	\$ 6.63
OR37683	1" x 3/4" Blu-Lock Reducing Tee	10	50	\$ 6.91
OR37684	3/4" x 1" x 3/4" Blu-Lock Bull Head Tee	10	50	\$ 7.96
OR37374	3/4" Blu-Lock 90 Degree Elbow	10	180	\$ 3.73
OR37673	1" Blu-Lock 90 Degree Elbow	10	60	\$ 5.15
OR37376	3/4" Blu-Lock Coupling	10	220	\$ 3.45
OR37377	3/4" x 1/2" Blu-Lock Reducing Coupling	10	250	\$ 3.36
OR37676	1" Blu-Lock Coupling	10	250	\$ 4.40
OR37685	1" x 1/2" Blu-Lock Reducing Coupling	10	100	\$ 4.78
OR37677	1" x 3/4" Blu-Lock Reducing Coupling	10	100	\$ 4.40
OR37383	1" MIPT x 3/4" Blu-Lock Reducing Coupling	10	250	\$ 2.39
OR37378	3/4" Male Adapter	10	250	\$ 2.39
OR37678	1" Male Adapter	10	150	\$ 3.48
OR37901	3/4" Barb x 1/2" Blu-Lock Adapter	25	200	\$ 2.39
OR37902	1" Barb x 1/2" Blu-Lock Adapter	25	200	\$ 2.39
OR37380	3/4" Blu-Lock Cap	10	250	\$ 2.39
OR37680	1" Blu-Lock Cap	10	150	\$ 3.73

## Drip-Lock Fittings



PART #	DESCRIPTION	BAG QTY.	PRICE
OR07490	1/2" Elbow	25	\$ 4.26
OR07491	1/2" Coupling	25	\$ 4.26
OR07492	1/2" Tee	25	\$ 7.19
OR07493	1/2" x 3/4" Adapter	25	\$ 3.21
OR07494	1/2" Adapter	25	\$ 2.94
OR07495	1/2" x 5/8" Adapter	25	\$ 3.74
OR07497	1/2" Valve Shut Off	25	\$ 7.41
OR07498	1/2" x MHT End Cap	25	\$ 3.98

## Release Tools



PART #	SIZE	QTY.	PRICE
OR08195	1" PVC Release Tool	5 pack	\$ 3.45
OR37908	1" Blu Lock Release Tool	5 pack	\$ 3.45
OR37909	3/4" Blu Lock Release Tool	5 pack	\$ 3.45



## Economy Valve Boxes

RAIN BIRD VALVE BOXES	DESCRIPTION	PRICE
AXVE608	6" Round Economy Valve Box (6" x 8" x 8")	\$ 8.06
AXVE910	10" Round Economy Valve Box (10" x 12" x 10")	\$ 27.56
AXVE14196	6" Deep Rectangular Box (18" x 13" x 6")	\$ 44.64
AXVE141912	12" Deep Rectangular Valve Box (21" x 16" x 12")	\$ 64.91

## Commercial Valve Boxes

RAIN BIRD VALVE BOXES	DESCRIPTION	PRICE
AXV708	7" round, single valve, 8" deep	\$ 35.28
AXV910	10" round, locking optional (13" deep)	\$ 40.50
AXV14196EXT	6" Deep standard rectangular - no lid (20" x 14" x 6")	\$ 46.75
AXV1419G-LID	Green lid for 14196	\$ 19.46
AXV141912	12" deep standard rectangular (21" x 16" x 12")	\$ 81.92
AXV13206	6" deep jumbo rectangular - no lid (24" x 17" x 6")	\$ 75.25
AXV1320G-LID	Green lid for 13206	\$ 55.22
AXV132012	12" deep jumbo rectangular (26" x 19" x 12")	\$ 131.22
AXVBSPR	Super Jumbo (33" x 23" x 15")	\$ 503.91
AXVBMAXH	Maxi Jumbo (40" x 27" x 18")	\$ 875.18

## Valve Box Accessories & Lids

ACCESSORIES	DESCRIPTION	PRICE
AXVP1419B-LID	Black Lid for 14196EXT	\$ 15.60
AXVP1419P-LID	Purple Lid for 14196EXT	\$ 16.00
AXVP1320B-LID	Black Lid for 13206	\$ 41.60
AXVBLOCKH	Locking kit for Rain Bird valve boxes	\$ 7.47

Parts Discount



## Economy Valve Boxes



CARSON VALVE BOXES	DESCRIPTION	PRICE
EUVE608	6" round, single valve, (6" x 8" x 8")	\$ 8.00
EUVE910	10" round, single valve (10" x 12" x 10")	\$ 18.00
EUVE14196	6" deep standard rectangular box (18" x 13" x 6")	\$ 32.00

## Commercial Valve Boxes

CARSON BOXES	DESCRIPTION	PRICE
EUV708	8" Round, locking optional	\$ 39.00
EUV910	10" Round, locking optional (13" deep)	\$ 45.00
EUV14196	6" deep standard extension with lid (20" x 14" x 6")	\$ 49.00
EUV141912	12" deep standard rectangular	\$ 69.00
EUV13206	6" deep jumbo rectangular	\$ 83.00
EUV132012	12" deep jumbo rectangular	\$ 100.00

CHANNEL BOXES	DESCRIPTION	PRICE
MHSB173024	17" x 30" Opening 24" High	\$ 787.25
MHSB243624	24" x 36" Opening 24" High	\$ 938.00

## Valve Box Accessories & Lids

ACCESSORIES	DESCRIPTION	PRICE
EUBOLTKIT	Security Bolt with Clip Kit	\$ 6.85
EUP608C	6" Carson Round - Cover Only	\$ 4.64
EUP708C	8" Carson Round - Cover Only	\$ 7.07
EUP910LID-B	10" Carson Round - Cover Only - Black	\$ 26.89
EUP910LID-G	10" Carson Round - Cover Only - Grey	\$ 28.21
EUP910LID-T	10" Carson Round - Cover Only - Tan	\$ 26.37
EUP910TLID	10" Carson Round - Cover Only - Green	\$ 22.81
EUP1419LID	Green Carson Lid for 1419	\$ 33.59

Parts Discount



OPTIONAL BOLT KIT



# Polyethylene Pipe with the Stripe®



## EASY TO HANDLE

IPEX polyethylene pipe is made with low density PE 1404 resin to ensure ease of bending and assembly with insert fittings.



## STRENGTH

Extra wall thickness gives the pipe more durability in the field and makes it less susceptible to puncture, kinking, or other damage.

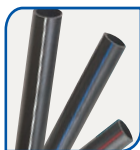

## EASY IDENTIFICATION

Pipe-with-the-Stripe has a coloured stripe extruded into the pipe wall for permanent identification of pressure and CSA or standard grade.

## EASY INSTALLATION

Sequential footage markings along the coil or reel length make it easy for cutting.

## DRINKING WATER APPROVALS

Red Stripe®, Green Stripe®, and Gold Stripe® are certified to CSA B137.1 standard for potable water.

1-866-473-9462 | [ipexna.com](http://ipexna.com)



**Pipe** with the  
**Stripe®**

Pipe-with-the-Stripe® is a registered trademark.



www.oilcreek.com



## Oil Creek Plastics

Black "poly pipe" is flexible irrigation pipe which comes in rolls in sizes from 3/4" to 2", although the great majority of applications use 1" or 3/4". Advantages include light weight, flexibility and easy to use insert fittings. Poly irrigation pipe can be easily installed using a vibratory plow with very little open trenching.



Oil Creek  
Swing Pipe

OIL CREEK • 100 PSI • MEDIUM DENSITY		PRICE/FOOT
TNNSF07100	3/4" x 100'	POR
TNNSF07400	3/4" x 400'	POR
TNNSF10100	1" x 100'	POR
TNNSF10300	1" x 300'	POR
TNNSF12300	1 1/4" x 300'	POR
TNNSF15250	1 1/2" x 250'	POR
TNNSF20100	2" x 100'	POR
TNNSF20200	2" x 200'	POR
TNOCSP100	SWING PIPE 100'	POR



**IPEX**

## IPEX Poly Pipe



IPEX IRRIGATION 2000 • 100 PSI • MEDIUM DENSITY • NON-CSA		PRICE/FOOT
TNIRR05400	1/2" x 400'	POR
TNIRR07400	3/4" x 400'	POR
TNIRR10300	1" x 300'	POR
TNIRR12300	1 1/4" x 300'	POR
TNIRR15250	1 1/2" x 250'	POR
TNIRR20100	2" x 100'	POR

## CSA Red Stripe Poly Pipe



CSA  
APPROVED FOR POTABLE  
WATER

IPEX CSA • 75 PSI • RED-STRIP • CSA APPROVED FOR POTABLE WATER		PRICE/FOOT
TNCSA07400	3/4" x 400'	POR
TNCSA10300	1" x 300'	POR
TNCSA12300	1 1/4" x 300'	POR
TNCSA15250	1 1/2" x 250'	POR
TNCSA20100	2" x 100'	POR





## Stainless Steel Gear Clamps

STAINLESS STEEL GEAR CLAMPS		BOX QTY.	CASE QTY.	PRICE
QGHF08SS	#8 clamp for 1/2" pipe	10	200	\$ 1.40
QGHF10SS	#10 clamp for 1/2" or 3/4" pipe	10	200	\$ 1.43
QGHF12SS	#12 clamp for 3/4" pipe	10	200	\$ 1.43
QGHF16SS	#16 clamp for 1" pipe	10	200	\$ 1.43
QGHF20SS	#20 clamp for 1 1/4" pipe	10	200	\$ 1.46
QGHF24SS	#24 clamp for 1 1/4" and 1 1/2" pipe	10	200	\$ 1.46
QGHF30SS	#30 clamp for 1 1/4" and 1 1/2" pipe	10	200	\$ 1.46
QGHF32SS	#32 clamp for 1 1/2" pipe	10	200	\$ 1.46
QGHF36SS	#36 clamp for 2" pipe	10	100	\$ 1.53



## Stainless Steel Crimp Style Clamps

STAINLESS OETIKER PINCH CLAMPS		BAG QTY.	PRICE
QG210R	1/2", for non-CSA pipe	100	\$ 0.30
QG256R	3/4", for non-CSA pipe	100	\$ 0.32
QG271R	3/4", for CSA pipe	100	\$ 0.31
QG331R	1", for non-CSA pipe	100	\$ 0.34
QG346R	1", for CSA pipe	100	\$ 0.35
QG425R	1 1/4", for non-CSA pipe	100	\$ 0.40
PINCH TOOLS		BAG QTY.	PRICE
QG1097	Dawn Economy Pincers	N/A	\$ 23.07
QG1800E	Short handle, 6" long	6	\$ 47.00
QG2800E	Long handle, 8" long	6	\$ 85.00

# Oetiker Connecting Solutions For Irrigation System Connections



Reliable Connections



### 1-Ear Clamps with mechanical interlock 155

#### Benefits and features

- Quick and easy to install
- Slim, lightweight, yet strong
- Stainless steel DIN 1.4301 / UNS S30400
- For polyethylene pipe sizes from 1/2" to 1"
- Ideal for low-pressure applications: 80 to 125 PSI
- Proprietary design increases clamping force to ensure a strong, durable connection



### Hand Installation Pincers (HIP)

Single Action Pincer - Extra Reach\*  
HIP 1000 | 426 (Item no. 14100426)

#### Benefits and features

- \*Extra reach: longer handles = better access to clamps in hard to reach locations
- Top sealing performance
- Quick and easy installation
- Ergonomic grip
- Recommended for the installation of Genuine Oetiker Ear Clamps

View all our reliable solutions at [Oetiker.com](http://Oetiker.com)

Contact us at: Oetiker, Inc., Michigan | 989.635.7678 | [info.us.marlette@oetiker.com](mailto:info.us.marlette@oetiker.com)



# IRRIGATION PIPE

Residential and  
Commercial  
Installations



**OIL CREEK  
PLASTICS**  
QUALITY. SERVICE. INTEGRITY.

**LIFETIME LIMITED  
WARRANTY**

*You can depend on it!*



### INSERT TEE

PART #	SIZE "	BOX QTY.	PRICE EACH
BA1401-005	1/2	50	\$ 2.61
BA1401-007	3/4	50	\$ 2.44
BA1401-010	1	25	\$ 3.15
BA1401-012	1¼	10	\$ 4.92
BA1401-015	1½	10	\$ 5.58
BA1401-020	2	10	\$ 12.85
BA1401-030	3	10	\$ 49.09



### REDUCING INSERT TEE

PART #	SIZE "	BOX QTY.	PRICE EACH
BA1401-099	3/4 x 3/4 x swing pipe	25	\$ 4.30
BA1401-101	3/4 x 3/4 x 1/2	25	\$ 3.40
BA1401-129	1 x 1 x swing pipe	25	\$ 4.69
BA1401-130	1 x 1 x 1/2	25	\$ 3.98
BA1401-131	1 x 1 x 3/4	25	\$ 4.01
BA1401-166	1¼ x 1¼ x 1/2	25	\$ 5.22
BA1401-167	1¼ x 1¼ x 3/4	25	\$ 5.22
BA1401-168	1¼ x 1¼ x 1	25	\$ 5.22
BA1401-209	1½ x 1½ x 1/2	10	\$ 9.10
BA1401-210	1½ x 1½ x 3/4	10	\$ 9.10
BA1401-211	1½ x 1½ x 1	10	\$ 8.59
BA1401-212	1½ x 1½ x 1¼	10	\$ 8.59
BA1401-247	2 x 2 x 1/2	10	\$ 12.95
BA1401-248	2 x 2 x 3/4	10	\$ 12.95
BA1401-249	2 x 2 x 1	10	\$ 12.95
BA1401-250	2 x 2 x 1¼	10	\$ 13.54
BA1401-251	2 x 2 x 1½	10	\$ 13.17



### REDUCING INSERT TEE

PART #	SIZE "	BOX QTY.	PRICE EACH
BA1401-094	3/4 x 1/2 x 1/2	25	\$ 3.72
BA1401-125	1 x 3/4 x 3/4	25	\$ 6.47
BA1401-157	1¼ x 1 x 3/4	25	\$ 7.43
BA1401-158	1¼ x 1 x 1	25	\$ 7.43
BA1401-202	1½ x 1¼ x 1	10	\$ 9.32



### "BULLHEAD" INSERT TEE

PART #	SIZE "	BOX QTY.	PRICE EACH
BA1401-074	1/2 x 1/2 x 3/4	25	\$ 7.47
BA1401-102	3/4 x 3/4 x 1	25	\$ 8.60
BA1401-132	1 x 1 x 1¼	25	\$ 12.00



### FIPT X INSERT TEE

PART #	SIZE "	BOX QTY.	PRICE EACH
BA1402-124	1 x 3/4 x 1/2	25	\$ 6.12
BA1402-125	1 x 3/4 x 3/4	25	\$ 7.29
BA1402-157	1¼ x 1 x 3/4	25	\$ 10.57



### MIPT X INSERT TEE

PART #	SIZE "	BOX QTY.	PRICE EACH
BA1403-005	1/2	50	\$ 3.83
BA1403-007	3/4	50	\$ 4.40
BA1403-010	1	25	\$ 6.68
BA1403-012	1¼	10	\$ 8.72
BA1403-015	1½	10	\$ 9.75



### FIPT X INSERT TEE

PART #	SIZE "	BOX QTY.	PRICE EACH
BA1402-005	1/2	50	\$ 3.01
BA1402-101	3/4 x 3/4 x 1/2	25	\$ 3.50
BA1402-007	3/4	50	\$ 4.23
BA1402-130	1 x 1 x 1/2	25	\$ 4.65
BA1402-131	1 x 1 x 3/4	25	\$ 4.65
BA1402-010	1	25	\$ 5.00
BA1402-012	1¼	10	\$ 7.80
BA1402-166	1¼ x 1¼ x 1/2	25	\$ 6.68
BA1402-167	1¼ x 1¼ x 3/4	25	\$ 7.38
BA1402-168	1¼ x 1¼ x 1	25	\$ 6.62
BA1402-209	1½ x 1½ x 1/2	10	\$ 10.29
BA1402-210	1½ x 1½ x 3/4	10	\$ 12.20
BA1402-211	1½ x 1½ x 1	10	\$ 10.33
BA1402-015	1½	10	\$ 12.75
BA1402-247	2 x 2 x 1/2	10	\$ 13.79
BA1402-248	2 x 2 x 3/4	10	\$ 14.60
BA1402-249	2 x 2 x 1	10	\$ 13.54
BA1402-251	2 x 2 x 1½	10	\$ 14.22
BA1402-020	2	10	\$ 16.81



### INSERT 90° ELBOW

PART #	SIZE "	BOX QTY.	PRICE EACH
BA1406-005	1/2	50	\$ 2.40
BA1406-007	3/4	50	\$ 2.91
BA1406-010	1	25	\$ 3.21
BA1406-012	1¼	10	\$ 3.60
BA1406-015	1½	10	\$ 4.21
BA1406-020	2	10	\$ 5.94
BA1406-101	3/4 x 1/2	25	\$ 2.92
BA1406-168	1¼ x 1	25	\$ 5.31



### INSERT X FIPT 90° ELBOW

PART #	SIZE "	BOX QTY.	PRICE EACH
BA1407-005	1/2	50	\$ 2.72
BA1407-101	1/2 x 3/4	50	\$ 2.79
BA1407-007	3/4	50	\$ 2.90
BA1407-130	1 x 1/2	25	\$ 2.90
BA1407-131	1 x 3/4	25	\$ 3.38
BA1407-010	1	25	\$ 3.74
BA1407-166	1¼ x 1/2	25	\$ 5.31
BA1407-167	1¼ x 3/4	25	\$ 5.31
BA1407-168	1¼ x 1	25	\$ 5.00
BA1407-012	1¼	10	\$ 5.89
BA1407-211	1½ x 1	10	\$ 5.70
BA1407-212	1½ x 1¼	10	\$ 6.22
BA1407-015	1¼	10	\$ 6.28
BA1407-251	2 x 1½	10	\$ 10.73
BA1407-020	2	10	\$ 9.55



### MIPT X INSERT 90° ELBOW

PART #	SIZE "	BOX QTY.	PRICE EACH
BA1413-005	1/2	50	\$ 2.72
BA1413-007	3/4	50	\$ 4.19
BA1413-010	1	25	\$ 5.42
BA1413-012	1¼	10	\$ 7.67
BA1413-015	1½	10	\$ 9.62
BA1413-020	2	10	\$ 16.08





**TAP ELBOW**

PART #.	SIZE "	BOX QTY.	PRICE EACH
BA1414-101	3/4 X 1/2	50	\$ 7.29
BA1414-130	1 X 1/2	25	\$ 7.83
BA1414-131	1 X 3/4	50	\$ 7.29



**CROSS**

PART #	SIZE "	BOX QTY.	PRICE EACH
BA1420-007	3/4	25	\$ 7.25
BA1420-010	1	25	\$ 8.99



**INSERT COUPLING**

PART #	SIZE "	BOX QTY.	PRICE EACH
BA1429-005	1/2	50	\$ 1.21
BA1429-007	3/4	50	\$ 1.51
BA1429-010	1	50	\$ 1.57
BA1429-012	1¼	25	\$ 2.25
BA1429-015	1½	25	\$ 2.71
BA1429-020	2	10	\$ 5.12
BA1429-030	3	10	\$ 23.57
BA1429-040	4	10	\$ 32.08



**REDUCING INSERT COUPLING**

PART #	SIZE "	BOX QTY.	PRICE EACH
BA1429-099	3/4 x swing pipe	50	\$ 2.79
BA1429-101	3/4 x 1/2	50	\$ 2.01
BA1429-129	1 x swing pipe	50	\$ 2.98
BA1429-130	1 x 1/2	50	\$ 2.85
BA1429-131	1 x 3/4	50	\$ 2.04
BA1429-167	1¼ x 3/4	25	\$ 4.42
BA1429-168	1¼ x 1	25	\$ 3.21
BA1429-210	1½ x 3/4	25	\$ 5.41
BA1429-211	1½ x 1	25	\$ 4.85
BA1429-212	1½ x 1¼	25	\$ 3.77
BA1429-249	2 x 1	10	\$ 7.29
BA1429-250	2 x 1¼	10	\$ 6.78
BA1429-251	2 x 1½	10	\$ 6.06



**INSERT FEMALE ADAPTER**

PART #	SIZE "	BOX QTY.	PRICE EACH
BA1435-005	1/2	50	\$ 5.65
BA1435-007	3/4	50	\$ 6.12
BA1435-010	1	50	\$ 6.78
BA1435-012	1¼	25	\$ 8.32
BA1435-015	1½	25	\$ 10.57
BA1435-020	2	10	\$ 13.44



**INSERT MALE ADAPTER**

PART #	SIZE "	BOX QTY.	PRICE EACH
BA1436-005	1/2	50	\$ 1.25
BA1436-007	3/4	50	\$ 1.48
BA1436-010	1	50	\$ 1.52
BA1436-012	1¼	20	\$ 2.41
BA1436-015	1½	25	\$ 2.69
BA1436-020	2	10	\$ 5.12
BA1436-030	3	10	\$ 25.71
BA1436-040	4	10	\$ 35.74



**REDUCING MALE ADAPTER**

PART #	SIZE "	BOX QTY.	PRICE EACH
BA1436-074	1/2 x 3/4	50	\$ 4.01
BA1436-075	1/2 x 1	50	\$ 4.18
BA1436-102	3/4 x 1	50	\$ 4.18
BA1436-132	1 x 1¼	25	\$ 5.04
BA1436-133	1 x 1½	25	\$ 7.63
BA1436-169	1¼ x 1½	10	\$ 7.63
BA1436-213	2 x 1½	10	\$ 9.77



**REDUCING MALE ADAPTER**

PART #	SIZE "	BOX QTY.	PRICE EACH
BA1436-101	3/4 x 1/2	50	\$ 3.45
BA1436-131	1 x 3/4	50	\$ 3.50
BA1436-167	1¼ x 3/4	25	\$ 4.42
BA1436-168	1¼ x 1	25	\$ 4.50
BA1436-211	1½ x 1	25	\$ 5.42
BA1436-212	1½ x 1¼	25	\$ 5.42
BA1436-251	2 x 1½	10	\$ 9.16



**INSERT PLUG**

PART #	SIZE "	BOX QTY.	PRICE EACH
BA1449-005	1/2	100	\$ 2.29
BA1449-007	3/4	100	\$ 2.39
BA1449-010	1	50	\$ 3.22
BA1449-012	1¼	25	\$ 4.08
BA1449-015	1½	25	\$ 4.46
BA1449-020	2	10	\$ 7.87

**What is 1 Inch of Water**

One inch of water a week is generally recommended as the minimum quantity for maintaining a viable landscape including vegetables, turf, trees and flowers.

But what is 1 inch of water?

The following conversions help make this clear.  
1 inch of water (applied or rainfall)

- on 1,000 square feet = 624 gallons or 5,200 pounds
- on 1 acre = 27,200 gallons or 227,120 pounds
- on 1 square mile = 17.4 million gallons or 145 million pounds

1 gallon equals

- 128 fluid ounces, 8.337 pounds, 3.782 kilograms
- 15,100 drops, 16 cups, 8 pints, 4 quarts
- 231 cubic inches, 0.2337 cubic feet
- 0.83262 British or Imperial gallon
- 3,785.4 millilitres or cubic centimetres

1 cubic foot equals 7.48 gallons, 62.4 pounds

1 cubic yard equals 202 gallons, 1,685 pounds, 764.5 litres

1 cubic meter equals 164.2 gallons, 2,002 pounds

1 acre-foot (12-inch depth across 43,560 square feet) equals 325,851 gallons, 2.7 million pounds



**LASCO**  
Fittings, Inc.

www.lascofittings.com



BA481-007



BA481-008

PART #	DESCRIPTION	BOX QTY.	PRICE
BAM481-005	1/2" x 6" cut-off	50	\$ 3.33
BAM481-007	3/4" x 6" cut-off	25	\$ 4.93
BAM481-101	3/4" (top thread) x 1/2" (x bottom 6")	50	\$ 3.76
PVC NIPPLES SCHEDULE 80			
PART #	DESCRIPTION	BOX QTY.	PRICE
BA882-101	1/2" MIPT x 3/4" MIPT reducing	50	\$ 2.01
BA205-011	1/2" x 1 1/8" (close)	50	\$ 1.01
BA205-020	1/2" x 2" (short)	50	\$ 1.21
BA205-025	1/2" x 2 1/2"	50	\$ 1.36
BA205-030	1/2" x 3"	50	\$ 1.51
BA205-040	1/2" x 4"	50	\$ 1.65
BA205-060	1/2" x 6"	50	\$ 2.13
BA205-080	1/2" x 8"	50	\$ 2.49
BA205-100	1/2" x 10"	50	\$ 2.99
BA205-120	1/2" x 12"	50	\$ 3.36
BA205-160	1/2" x 16"	50	\$ 4.07
BA205-180	1/2" x 18"	50	\$ 4.63
BA205-240	1/2" x 24"	50	\$ 5.56
BA205-360	1/2" x 36"	50	\$ 44.85
BA205-480	1/2" x 48"	50	\$ 16.39
BA207-013	3/4" x 1 3/8" (close)	50	\$ 1.07
BA207-020	3/4" x 2" (short)	50	\$ 1.36
BA207-030	3/4" x 3"	50	\$ 1.57
BA207-040	3/4" x 4"	50	\$ 1.87
BA207-060	3/4" x 6"	50	\$ 1.87
BA207-080	3/4" x 8"	50	\$ 3.07
BA207-100	3/4" x 10"	50	\$ 8.06
BA207-120	3/4" x 12"	50	\$ 3.59
BA207-180	3/4" x 18"	50	\$ 4.05
BA207-240	3/4" x 24"	25	\$ 15.40
BA207-300	3/4" x 30"	25	\$ 18.44
BA207-360	3/4" x 36"	25	\$ 11.79
BA207-480	3/4" x 48"	25	\$ 17.46
BA210-015	1" x 1 1/2" (close)	50	\$ 1.58
BA210-020	1" x 2" (short)	50	\$ 1.82
BA210-030	1" x 3"	50	\$ 2.32
BA210-040	1" x 4"	50	\$ 2.71
BA210-060	1" x 6"	50	\$ 3.72
BA210-080	1" x 8"	50	\$ 4.33
BA210-100	1" x 10"	50	\$ 4.36
BA210-120	1" x 12"	50	\$ 14.36
BA210-180	1" x 18"	50	\$ 6.16
BA210-240	1" x 24"	20	\$ 8.39
BA212-016	1 1/4" x 1 5/8" (close)	25	\$ 2.38
BA212-020	1 1/4" x 2" (short)	25	\$ 2.53
BA212-025	1 1/4" x 2 1/2"	25	\$ 2.53
BA212-030	1 1/4" x 3"	25	\$ 3.04
BA212-040	1 1/4" x 4"	25	\$ 3.48
BA215-017	1 1/2" x 1 5/8" (close)	25	\$ 2.99
BA215-020	1 1/2" x 2" (short)	25	\$ 3.18
BA215-030	1 1/2" x 3"	25	\$ 3.72
BA215-040	1 1/2" x 4"	25	\$ 4.27
BA215-060	1 1/2" x 6"	25	\$ 4.65
BA215-080	1 1/2" x 8"	25	\$ 5.55
BA215-120	1 1/2" x 12"	25	\$ 8.81
BA220-020	2" x 2" (close)	10	\$ 3.90
BA220-025	2" x 2 1/2" (short)	10	\$ 4.33
BA220-030	2" x 3"	10	\$ 4.64
BA220-060	2" x 6"	10	\$ 5.21
BA220-080	2" x 8"	10	\$ 7.22
BA220-100	2" x 10"	10	\$ 10.13
BA225-025	2 1/2" x 2 1/2" (close)	5	\$ 8.18
BA230-026	3" x 2 1/2"	5	\$ 10.60
BA230-030	3" x 3"	5	\$ 11.35

All wire prices are subject to change without notice.

18 GAUGE - MULTI-STRAND - HEAVY DUTY WIRE		QTY.	PRICE per Roll	PRICE per Foot
AE18500-2	2 Conductors	500'	\$ 150.00	\$ 0.30
AE18500-3	3 Conductors	500'	\$ 210.00	\$ 0.42
AE18500-4	4 Conductors	500'	\$ 260.00	\$ 0.52
AE18500-5	5 Conductors	500'	\$ 320.00	\$ 0.64
AE18500-6	6 Conductors	500'	\$ 365.00	\$ 0.73
AE18500-7	7 Conductors	500'	\$ 420.00	\$ 0.84
AE18500-8	8 Conductors	500'	\$ 480.00	\$ 0.96
AE18500-10	10 Conductors	500'	\$ 590.00	\$ 1.18
AE18500-12	12 Conductors	500'	\$ 690.00	\$ 1.38
20 GAUGE - MULTI-STRAND - STANDARD DUTY				
AE20500-2	2 Conductors	500'	\$ 150.00	\$ 0.30
AE20500-3	3 Conductors	500'	\$ 220.00	\$ 0.44
AE20500-4	4 Conductors	500'	\$ 250.00	\$ 0.50
AE20500-5	5 Conductors	500'	\$ 290.00	\$ 0.58
AE20500-6	6 Conductors	500'	\$ 320.00	\$ 0.64
AE20500-7	7 Conductors	500'	\$ 350.00	\$ 0.70
AE20500-8	8 Conductors	500'	\$ 400.00	\$ 0.80
AE20500-10	10 Conductors	500'	\$ 500.00	\$ 1.00
AE20500-12	12 Conductors	500'	\$ 580.00	\$ 1.16
20 GAUGE - MULTI-STRAND - SHORT COIL				
AE20100-7	7 Conductors	100'	\$ 107.00	\$ 1.07
CONTROL & COMMON WIRE - PLEASE SPECIFY COLOUR WHEN ORDERING				
AE141PE	14 Gauge, Single Conductor, Solid (blue, brown, green, orange, pink, purple, red, white, yellow)	2500'	\$ 975.00	\$ 0.39
AE141PE-Black	14 Gauge, Single Conductor, Solid	2500'	\$ 975.00	\$ 0.39
AE121PE-White	12 Gauge, Single Conductor, Solid	2500'	\$ 1,500.00	\$ 0.60
AE142MAXI	14 Gauge, 2 Conductors (red, blue, white, yellow)	2500'	\$ 3,525.00	\$ 1.41
AE142MAXI-1000	14 Gauge, 2 Conductors (red, blue, yellow)	1000'	\$ 1,410.00	\$ 1.41
AE142TWIST	14 Gauge, 2 Conductors twisted (Hunter)	1000'	\$ 1,410.00	\$ 1.41
AEUFSTRIP	Cable Stripper for Maxi Cable	each	N/A	\$ 20.51
POWER WIRE - HIGH VOLTAGE APPLICATIONS				
AE142NMWU-B	14 Gauge, 2 Conductors and Bare Ground	1000'	\$ 1,760.00	\$ 1.76
AE122NMWU	12 Gauge, 2 Conductors and Bare Ground	1000'	\$ 2,120.00	\$ 2.12
AE102NMWU	10 Gauge, 2 Conductors and Bare Ground	1000'	\$ 2,470.00	\$ 2.47
AE82NMWUB	8 Gauge, 2 Conductors and Bare Ground	1000'	\$ 5,090.00	\$ 5.09
AE62NMWUB	6 Gauge, 2 Conductors and Bare Ground	1000'	\$ 7,870.00	\$ 7.87
GROUND WIRE & GROUNDING ACCESSORIES				
AE6BARE	6 Gauge, Bare Copper, Multi Strand	250'	\$ 372.50	\$ 1.49
AE1058-CC	5/8" x 10' Copper Clad Ground Rod	each	N/A	\$ 86.00
AEHDC34	Brass Grounding Clamps 3/4"	each	N/A	\$ 13.16
AEHDC58	Brass Grounding Clamps 5/8"	each	N/A	\$ 14.25
AEESB6	Split Bolt Clamp for Grounding Wire	each	N/A	\$ 6.79
AE182201	Ground Plate 4" x 36" w/10' of 6BARE	each	N/A	\$ 372.00
AE182199L	Ground Plate 4" x 96" w/25' of 6BARE	each	N/A	\$ 631.00
AEAG2401	Surge Arrestor (110/220 V)	each	N/A	\$ 315.74
AXLSP-1	Rain Bird Lightning Arrestor for Decoders only	each	N/A	\$ 263.47
AXMSP-1	Rain Bird Surge Arrestor Pipe for Communication	each	N/A	\$ 1,281.06
AXMGPI	Rain Bird Mounting Bracket for AXMSP-1	each	N/A	\$ 713.51
AEPOWERSET	Enhanced Backfill Compound	each	N/A	\$ 375.02
TRACER & PUMP WIRE				
AERWU90-YELLOW	Yellow Tracer Wire	2500'	\$ 2,300.00	\$ 0.92
AE124TWUP	Pump wire for Submersibles	50'	N/A	\$ 2.02





## 3M Crimp Connectors

PART #	DESCRIPTION	BAG/BOX QTY.	PRICE
AE316	Insert wires and crimp shut	30/300	\$ 1.67



## KING DryConn Connectors

PART #	DESCRIPTION	PART #	QTY.	PRICE
MBKW	Black & White - up to 3 x 16g conductors	61135	25	\$ 1.86/EACH
MBKWCAN	Black & White - up to 3 x 16g conductors	61146	150	\$ 191.74
MBKW500	Black & White - up to 3 x 16g conductors	61148	500	\$ 586.07
MBKG	Black & Grey - up to 2 x 12g conductors	61235	20	\$ 2.31/EACH
MBKGCAN	Black & Grey - up to 2 x 12g conductors	61241	100	\$ 163.77
MBKG500	Black & Grey - up to 2 x 12g conductors	61242	500	\$ 736.46
MBKB	Black & Blue - up to 3 x 12g conductors	61335	10	\$ 2.80/EACH
MBKBKAN	Black & Blue - up to 3 x 12g conductors	61350	50	\$ 133.89



## 3M COM/Line Voltage Connectors

PART #	DESCRIPTION	BOX QTY.	PRICE
AEDBRY-6	Low voltage, New 1 Size Combo Unit	100	\$ 3.80
AE8510	CSA, 1000 V, 7/16" OD	10	\$ 103.04
AE8512	CSA, 1000 V, 3/4" OD	10	\$ 111.04
AERY-BULK	Marret for DBRY	100	\$ 0.29



## King Power Cord

PART #	DESCRIPTION	BOX QTY.	PRICE
MBPIGTAIL	6' power cord, 90° angle plug, 16g with ground	20	\$ 7.73

## Electrical Tools

Greenlee has been in the electrical testing and measurement field for more than fifteen years and has developed a wide range of electrical testers designed by and for professional electricians.



AKPRO700

PART #	DESCRIPTION	BOX QTY.	PRICE
AKPRO700	Armada Wire Tracker	1	\$ 961.11
AKPRO800	Armada Wire Locator with Rechargeable Batteries	1	\$ 1,250.01
AKPRO95	Armada Multi-meter with Milliamp Clamp	1	\$ 415.39
AKPRO50	Armada digital solenoid activator & multi-meter	1	\$ 227.00
AKPRO48	Armada soldenoid activator	1	\$ 160.79
AKPRO40	Armada true RMS digital multi-meter	1	\$ 84.00

Contact your Sales Rep or Territory Manager for inquiries about PRO 700 rentals.  
Advanced bookings required for loaner units.



Watts Water Technologies, Inc.

## Backflow Prevention

Backflow is the undesirable reversal of flow of non-potable water or other substances, through a cross-connection and into the piping of a public water system or potable water system. Lead free products are not required for irrigation and fire protection.



TFICV075



TFLF7RU22075

### Dual Check

Not approved by CSA plumbing code for irrigation use.

- Sizes: 3/4", 1" (FIPT.)
- Applications: Residential water service
- ASSE Listed 1015, built to CSA standards
- Can be mounted vertically or in a horizontal position



DUAL CHECK		PRICE
TFICV075	3/4" inline dual check, Lead Free	\$ 76.00
TFICV100	1" inline dual check, Lead Free	\$ 83.00
TFLF7RU22075	Watts 3/4" inline dual check, Lead Free	\$ 56.00
TFLF7RU221	Watts 1" inline dual check, Lead Free	\$ 56.00



Apollo Double Check Assembly



Watts Double Check Assembly

### Double Check Assembly

- Sizes: 3/4", 1", 1 1/2", 2"; replaceable seats
- ASSE Listed 1015, CSA Certified; IAPMO Listed
- Can be installed below grade



DOUBLE CHECK ASSEMBLY		PRICE
TFDCA075	Conbraco 3/4" DCA	\$ 388.40
TFDCA100	Conbraco 1" DCA	\$ 471.28
TFDCA150	Conbraco 1 1/2" DCA	\$ 903.50
TFDCA200	Conbraco 2" DCA	\$ 1,101.75
TF007M3QT075	Watts 3/4" DCA	\$ 287.52
TF007M1QT1	Watts 1" DCA	\$ 380.18
TF007M2QT15	Watts 1 1/2" DCA	\$ 814.22
TF007M1QT2	Watts 2" DCA	\$ 853.84



Apollo Pressure Vacuum Breaker



Watts Pressure Vacuum Breaker

### Pressure Vacuum Breaker

- High hazard - install at least 12" above highest sprinkler head.
- Sizes: 3/4", 1", 1 1/2", 2"
- ASSE Listed 1015, CSA Certified; IAPMO Listed
- Replaceable seats
- Vents to atmosphere



PRESSURE VACUUM BREAKER		PRICE
TFPVB075	3/4" PVB	\$ 265.00
TFPVB100	1" PVB	\$ 273.00
TFPVB150	1 1/2" PVB	\$ 656.00
TFPVB200	2" PVB	\$ 900.00
TF800M4FR075	Watts 3/4" PVB	\$ 194.18

### Reduced Pressure Assembly

- Sizes: 3/4", 1", 1 1/2", 2"
- Protects against back siphonage & back pressure
- ASSE Listed 1015, CSA Certified; IAPMO Listed
- Replaceable seats
- High Hazard
- Vents to atmosphere

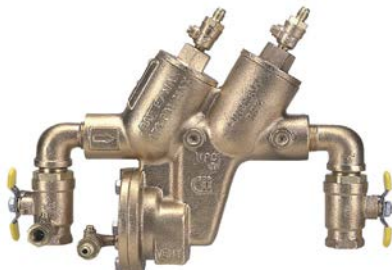

Reduced Pressure Assembly

REDUCED PRESSURE ASSEMBLY		PRICE
TFRPA100	1" RPA	\$ 612.48
TFRPA150	1 1/2" RPA	\$ 1,089.72
TFRPA200	2" RPA	\$ 1,350.54

Backflow prevention products are required by all municipal plumbing codes. Please consult with your local plumbing codes.



# Copper Pipe & Fittings

Copper Pipe & Fittings prices are subject to change without notice



## TEE

PART #	SIZE "	BOX QTY.	PRICE
OH901-007	3/4	25	\$ 4.31
OH901-074	1/2 x 1/2 x 3/4	25	\$ 7.74
OH901-101	3/4 X 3/4 x 1/2	10	\$ 3.53



## COUPLER WITH STOPS

PART #	SIZE "	BOX QTY.	PRICE
OH929-007	3/4	50	\$ 1.22
OH929-010	1	25	\$ 2.55
OH929-101	3/4 x 1/2	50	\$ 4.67



## 90 ° ELBOW (SOLDER X SOLDER)

PART #	SIZE "	BOX QTY.	PRICE
OH906-007	3/4	25	\$ 3.33
OH906-010	1	20	\$ 4.50



## FEMALE ADAPTER (SOLDER X FIPT)

PART #	SIZE "	BOX QTY.	PRICE
OH935-007	3/4	25	\$ 4.61
OH935-010	1	10	\$ 9.03
OH935-015	1½	10	\$ 39.91
OH935-020	2	5	\$ 55.46



## 90 ° ELBOW (SOLDER X FIPT)

PART #	SIZE "	BOX QTY.	PRICE
OH907-007	3/4	30	\$ 7.95



## MALE ADAPTER (SOLDER X MIPT)

PART #	SIZE "	BOX QTY.	PRICE
OH936-007	3/4	25	\$ 3.55
OH936-010	1	25	\$ 7.89
OH936-020	2	5	\$ 39.00
OH936-131	3/4 x 1	25	\$ 18.14



## REDUCER BUSHING

PART #	SIZE "	BOX QTY.	PRICE
OH937-131	1 x 3/4	25	\$ 3.50

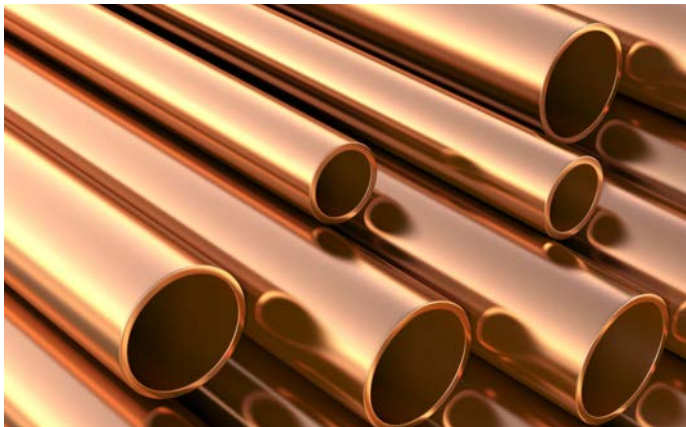

COPPER PIPE - TYPE "M"	SIZE "	LENGTH	PER/FT
OH075-MC	3/4	12'	\$ 5.76
OH100-MC	1	12'	\$ 8.46
OH150-MC	1½	12'	\$ 17.53
OH200-MC	2	12'	\$ 40.76

PLUMBING ACCESSORIES	DESCRIPTION	SIZE	PRICE
OHSC5	Emery cloth (sand paper)	1 1/2" x 15' roll	\$ 10.00
OHSLF5	Lead free solder	Roll	\$ 53.00
OHSP454	Acid based soldering flux	16oz tub	\$ 12.33

# Plumbing Pipe and Fittings



Watts Water Technologies, Inc.

## RAUPEX PEX Pipe

RAUPEX® crosslinked polyethylene (PEXa) pipe is manufactured using REHAU's high-pressure peroxide extrusion method that typically yields the highest, most consistent level of cross linking. RAUPEX is a durable, flexible pipe with enhanced temperature and pressure capabilities as well as long-term strength.



### PEX Pipe

PART #	SIZE	BOX QTY.	PRICE
MVPEX34100	3/4"	100ft	\$ 122.60
MVPEX1100	1"	100ft	\$ 193.33

## TECTITE Push Fittings



Clean, easy and efficient.

The jointing process is simple: no special tools, no flux, no solder, no flame. No problem! TECTITE offers an energy-efficient, safe, cost-effective installation.



### Coupling

PART #	SIZE	BOX QTY.	PRICE
TFTT10155454	3/4"	30	\$ 14.99



### Male Adapter

PART #	SIZE	BOX QTY.	PRICE
TFTT10155470	3/4"	30	\$ 11.99



### Elbow

PART #	SIZE	BOX QTY.	PRICE
TFTT10155478	3/4"	30	\$ 16.99



### Female Adapter

PART #	SIZE	BOX QTY.	PRICE
TFTT10155464	3/4"	30	\$ 11.99



### Reducing Coupler

PART #	SIZE	BOX QTY.	PRICE
TFTT10155460	1" x 3/4"	30	\$ 35.99



### Tee

PART #	SIZE	BOX QTY.	PRICE
TFTT10155488	3/4"	30	\$ 22.50



### Tools

PART #	SIZE	BOX QTY.	PRICE
TFRCLIP34	3/4"	15	\$ 2.50
TFRCLIP1	1"	10	\$ 2.50



### Ball Valve

PART #	SIZE	BOX QTY.	PRICE
TFTT10155523	3/4"	15	\$ 36.99





IRRITROL ELECTRIC VALVE



BRASS GATE VALVES



BRASS BALL VALVES



PVC BALL VALVES



BRASS SWING CHECK VALVES



BRASS BOILER DRAIN



STAINLESS 1/4 TURN HOSE BIB



BRASS HOSE Y



BRASS HOSE FITTING

## Irritrol Electric Valves

IRRITROL VALVES		PRICE
AJ2400-AT	1" Irritrol Solenoid Valve	\$ 47.73
AJ216PR	1.5" Irritrol Solenoid Valve	\$ 208.26
AJ217PR	2" Irritrol Solenoid Valve	\$ 284.70
AJPSOL24VAC	24 VAC Irritrol Solenoid	\$ 21.85

## Manual Valves

BRASS GATE VALVES		PRICE
DG05GV	1/2" FIPT	\$ 11.30
DG05GV-SW	1/2" solder	\$ 12.16
DG075GV	3/4" FIPT	\$ 15.40
DG075GV-SW	3/4" solder	\$ 16.60
DG100GV	1" FIPT	\$ 22.95
DG125GV	1 1/4" FIPT	\$ 32.35
DG150GV	1 1/2" FIPT	\$ 41.10
DG200GV	2" FIPT	\$ 62.60
DG200GVHD	2" FIPT, heavy duty	\$ 209.92
DG250GV	2 1/2" FIPT	\$ 115.65
DG250GVHD	2 1/2" FIPT, heavy duty	\$ 420.18
DG300GV	3" FIPT	\$ 157.15
DG300GVHD	3" FIPT, heavy duty	\$ 575.37
DG400GV	4" FIPT	\$ 243.15

BRASS BALL VALVES - "FULL PORT"		PRICE
DG05BVB-FP	1/2" FIPT	\$ 8.05
DG075BVB-FP	3/4" FIPT	\$ 13.27
DG075BVB-FPSW	3/4" solder	\$ 10.37
DG100BVB-FP	1" FIPT	\$ 19.81
DG100BVB-FPSW	1" solder	\$ 20.49
DG125BVB-FP	1 1/4" FIPT	\$ 30.75
DG150BVB-FP	1 1/2" FIPT	\$ 41.46
DG200BVB-FP	2" FIPT	\$ 64.00
DG250BVB-FP	2 1/2" FIPT	\$ 146.69
DG300BVB-FP	3" FIPT	\$ 197.29

ECONOMY PVC BALL VALVE		PRICE
BA0921-05	1/2" FIPT	\$ 3.51
BA0921S-05	1/2" SLIP	\$ 3.51
BA0921-07	3/4" FIPT	\$ 4.29
BA0921S-07	3/4" SLIP	\$ 4.29
BA0921-10	1" FIPT	\$ 5.91
BA0921S-10	1" SLIP	\$ 5.91
BA0921-15	1 1/2" FIPT	\$ 11.55
BA0921S-15	1 1/2" SLIP	\$ 11.55
BA0921-20	2" FIPT	\$ 15.91
BA0921S-20	2" SLIP	\$ 15.91

## Swing Check Valves

BRASS SWING CHECK VALVES		PRICE
FH150BSCV	1 1/2" FIPT	\$ 46.60
FH200BSCV	2" FIPT	\$ 76.87
FH300BSCV	3" FIPT	\$ 187.61

## Garden Hose Valves & Fittings

BOILER DRAINS (HOSE BIB)		PRICE
DG05GHT	1/2" MIPT, brass	\$ 5.88
DG075GHT	3/4" MIPT, brass	\$ 6.47
DG05BVB	1/2" MIPT, stainless steel, ball valve style (Hose Bib)	\$ 16.46

BRASS HOSE FITTINGS		PRICE
OR91700	Hose Y with shut off (58249)	\$ 20.62
DGBG1961212	Hose adapter 3/4" MIPT X MHT	\$ 3.35
DGBG199S1212	Hose swivel 3/4" FHT X FIPT	\$ 3.70
DGBG1991212	Adapter 3/4" FHT x 3/4" MIPT	\$ 3.15
DGBG20012	Cap 3/4" FHT	\$ 1.75

# PENTAIR BERKELEY®



### SN SERIES SHALLOW WELL JET PUMP

MODEL	HP	SUCTION (IN)	DISCHARGE (OUT)	VOLTAGE	AMPS	PRICE
FE5SN	1/2	1¼	1	115/230	8.8/4.4	\$ 561.12
FE7SN	3/4	1¼	1	115/230	12.2/6.1	\$ 620.57
FE10SN	1	1¼	1	115/230	14.8/7.4	\$ 789.58
FE15SN	1½	1¼	1	115/230	19.9/10	\$ 879.76

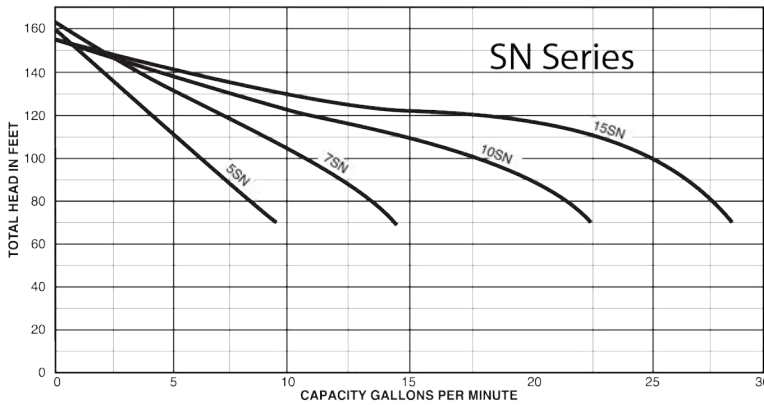

## Self Priming Pumps

Can bleed air from suction lines after initial prime.



### SELF-PRIMING CENTRIFUGAL PUMPS

MODEL	HP	SUCTION (IN)	DISCHARGE (OUT)	VOLTAGE	AMPS	PRICE
FELTH1	1	2	1½	115/230	14.8/7.4	\$ 631.93
FELTH150	1½	2	1½	115/230	20/10	\$ 876.42
FELTH2	2	2	2	230	24/12	\$ 1,208.41
FELTH250	2½	2	2	230	26/13	\$ 1,437.87

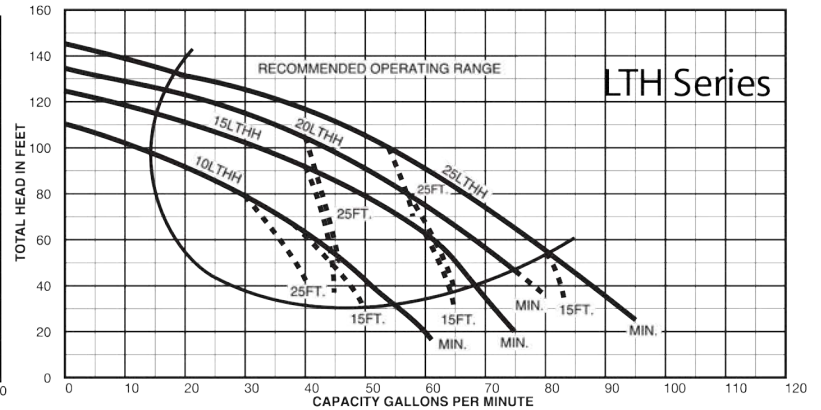

## Multi-Stage Centrifugal

For low volume and higher pressure situations.



### MULTI-STAGE CENTRIFUGAL PUMP

MODEL	HP	DISCHARGE (OUT)	VOLTAGE	AMPS	PRICE
FESSH2	2	1½	230	16	\$ 1,540.41

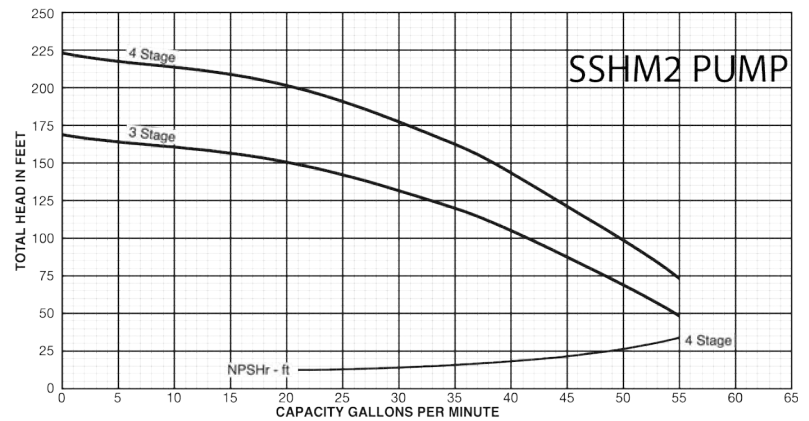

## Centrifugal Pumps

End suction centrifugal pumps are ideal for most irrigation applications producing high performance, easy maintenance and moderate initial cost.



## High Head Pressure Pumps

For use as main water supply.

### END SUCTION CENTRIFUGAL PRESSURE PUMPS

MODEL	HP	SUCTION (IN)	DISC (OUT)	VOLTAGE	AMPS	PRICE
FECP1XPHS1	1	1¼	1	115/230	16/8	\$ 767.86
FECP1XPHS15	1½	1¼	1	115/230	20/10	\$ 863.72
FECP125TPHS2	2	1½	1¼	230	12	\$ 1,024.71
FECP15TPHS25	2½	2	1½	230	15	\$ 1,232.46
FECP125TPMS3	3	1½	1¼	230	17	\$ 1,861.72
FECP1WPS75	7½	1½	1	230	40	\$ 3,778.21

## Medium Head Booster Pumps

For boosting pressure on service lines.

### END SUCTION CENTRIFUGAL BOOSTER PUMPS

MODEL	HP	SUCTION (IN)	DISC (OUT)	VOLTAGE	AMPS	PRICE
FECP125XPS1	1	1½	1¼	115/230	20/10	\$ 743.48
FECP125XPS15	1½	1½	1¼	115/230	20/10	\$ 762.19
FECP15XPS25	2½	2	1½	230	20/10	\$ 1,305.27





## DR-Series Booster Pumps

Recommended for projects with city water supplied but more pressure is needed.

MODEL	HP	PHASE	SUCTION (IN)	DISCHARGE (OUT)	VOLTAGE		Price
					115	230	
FRDR1S1-CP	1	1	1¼	1	19.9	9.9	\$ 674.14
FRDR2S15-CS	1½	1	1½	1¼	24.0	12.1	\$ 807.48
FRDR2S2-CS	2	1	1½	1¼	-	11.2	\$ 1,065.36

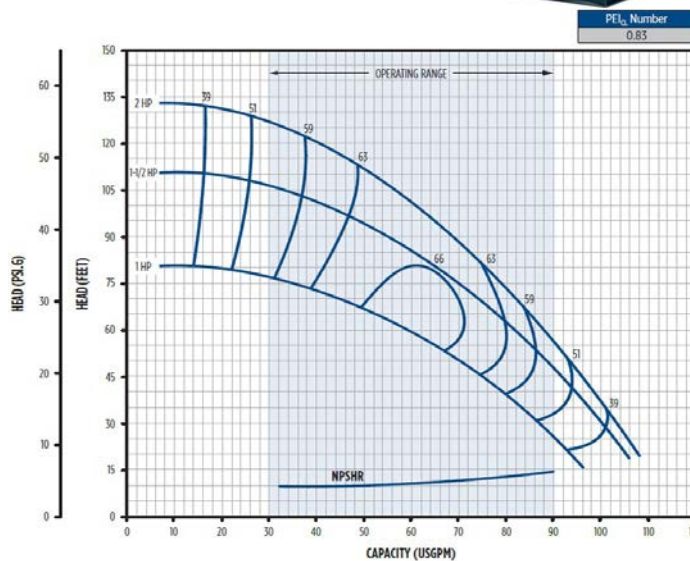
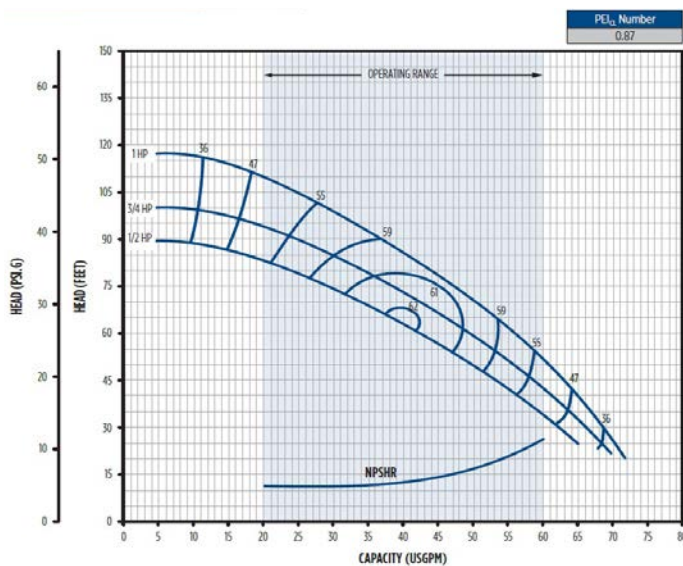

## Turf Boss Series

Recommended as a projects primary pressure pump for wells, tanks and ponds.



MODEL	HP	PHASE	SUCTION (IN)	DISCHARGE (OUT)	VOLTAGE		PRICE
					115	230	
FRFTB1CI	1	1	1½	1½	✓	✓	\$ 721.79
FRFTB15CI	1½	1	1½	1½	✓	✓	\$ 735.31
FRFTB2CI	2	1	1½	1½	✓	✓	\$ 918.82
FRFTB3CI	3	1	2	2	✓	✓	\$ 1,961.91
FRFTB5CI	5	1	2½	2	✓	✓	\$ 2,408.77



Turf Boss 1 & 2



Turf Boss 3 & 5

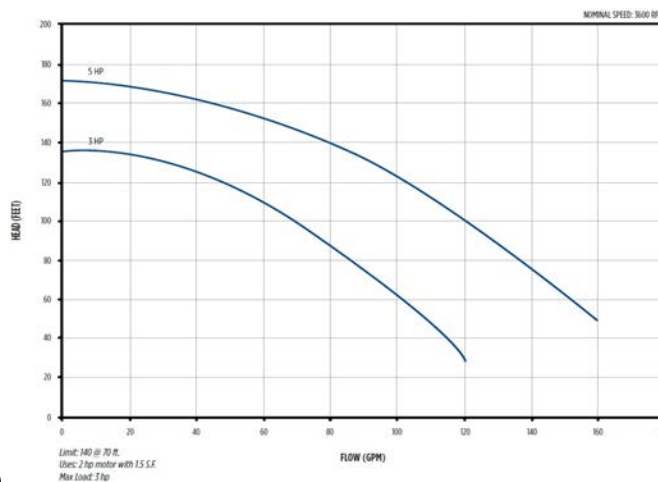
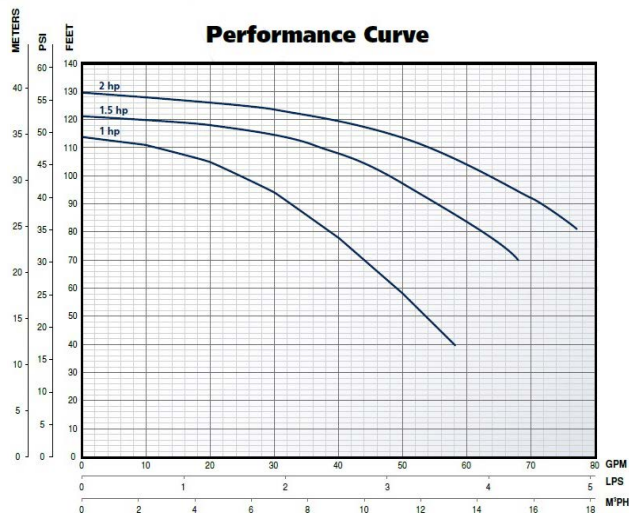

## Inline 400

Recommended for projects with city water supplied but more pressure is needed.

MODEL DESCRIPTION	ORDER NO.	HP	INPUT VOLTAGE	Hz	AMPS (FLA)	WATTS	PERFORMANCE (PSI @ GM)					CORD	WEIGHT (lbs)	PRICE
							0	5	10	15	20			
Inline 400 115 V	FR92061501	1/3	115	60	6.6	.25 kW	55	53	44	32	14	6' w/ plug	35	\$ 1,022.11
Inline 1100	FR92061501	1/3	115	60	6.6	.25kW	55	53	44	32	14	6' w/ plug	35	POR

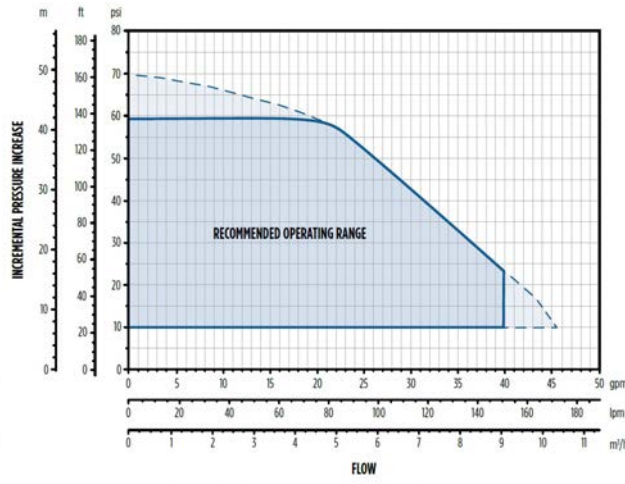
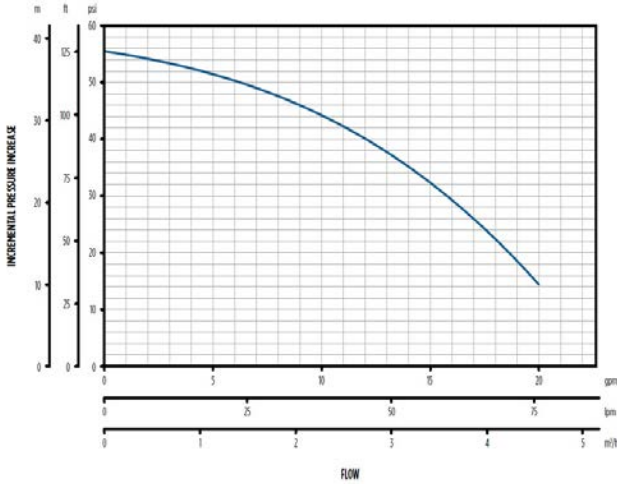

NOTE: Running outside of "Recommended Operating Range" for short periods of time is permissible.



## Inline Control

Recommended for cost effective pressure and flow base pump control.

MODEL DESCRIPTION	FLOW BASED ACTIVATION	RUN DRY PROTECTION	LOW-PRESSURE BACKUP ACTIVATION	REPLACES PRES. SWITCH TANK	SUCTION LIFT	INCLUDES PRES. GAUGE	ADJ. LOW-PRESSURE BACKUP ACTIVATION	PRICE
InlineADJ 115 V	✓	✓	✓	✓	✓	✓	✓	\$ 169.21
InlineADJ 230 V	✓	✓	✓	✓	✓	✓	✓	\$ 172.59

## Technical Specifications

MODEL DESCRIPTION	MOTER SIZE	VOLTAGE	MAX. CURRENT	MAX. TEMP	MIN. FLOW	THREAD SIZE
InlineADJ 115 V	up to .75 hp	115	16 A	150 ° F	.25 GPM	1" MNPT
InlineADJ 230 V	Up to 2 hp	230	16 A	150 ° F	.25 GPM	1" MNPT



## Inline Control Packages

MODEL DESCRIPTION	ORDER NO.	PUMP	CONTROL	HP	VOLTAGE	GPM	PSI	PRICE
Inline Control Booster Pump	FR15FMH05S2-SWC	MH	Inline SWC	1/2	115V	15	30	\$ 714.58
Inline Control Suction Lift	FRFVJ07CI-SWC	VersaJet	Inline SWC	3/4	115V	14	40	\$ 1,118.60

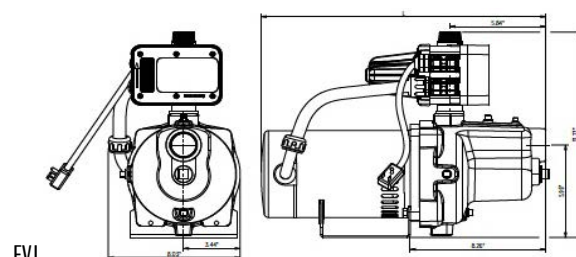
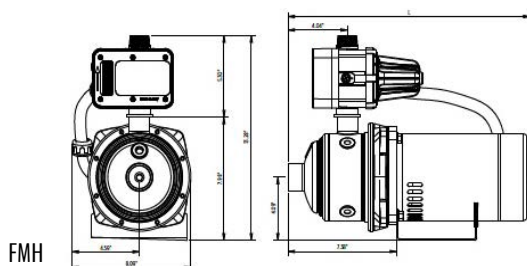



## 15 GPM Pumps

GPM	HP	STAGES	VOLTS	2-WIRE		3-WIRE	
				MODEL	PRICE	MODEL	PRICE
15	1/2	4	115	15FA05P4-2W115	\$ 856.24	15FA05P4-3W115	\$ 884.15
	1/2	4	230	15FA05P4-2W230	\$ 856.24	15FA05P4-3W230	\$ 884.15
	3/4	6	230	15FA07P4-2W230	\$ 940.28	15FA07P4-3W230	\$ 921.11
15	1/2	4	115	15FA05S4-2W115	\$ 940.28	15FA05S4-3W115	\$ 971.79
	1/2	4	230	15FA05S4-2W230	\$ 940.28	15FA05S4-3W230	\$ 971.79
	3/4	6	230	15FA07S4-2W230	\$ 1,026.58	15FA07S4-3W230	\$ 1,071.95

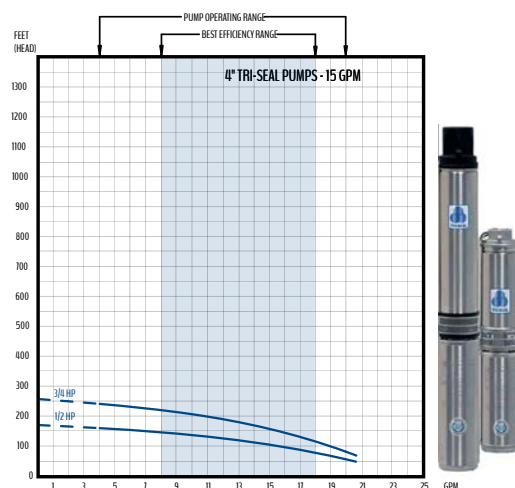

## Control Boxes

CONTROL BOX	VOLTS	HP	PRICE
2801044915	115	1/2	\$ 94.60
2801054915	230	1/2	\$ 94.60
2801074915	230	3/4	\$ 100.92

## 35 GPM Pumps

GPM	HP	STAGES	VOLTS	MODEL	ORDER NUMBER		PRICE
					WITH CHECKVALVE	WITHOUT CHECKVALVE	
35	1	6	230	35FA154-PE	90653506	93613506	\$ 1,336.66
	1.5	8	230	35FA154-PE	90653508	93613508	\$ 1,526.85

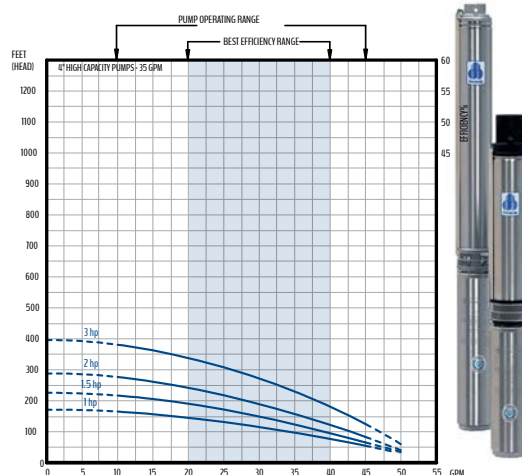

## Control Boxes

CONTROL BOX	VOLTS	HP	PRICE
2801084915	115	1	\$ 104.41
2823008110	230	1.5	\$ 148.57

## Submersible Pump Controls

	DRIVE MODEL	ORDER NO.	SINGLE-PHASE (3-WIRE)	THREE-PHASE
Submersible	SubDrive15	5870205103C	.5-1 HP	1 HP
	SubDrive20	5870205303C	.5-2 HP	.5-2 HP
	SubDrive30	5870205403C	.5-3 HP	.5-3 HP
	SubDrive50	5870205503C	.5-3 HP	.5-1 HP

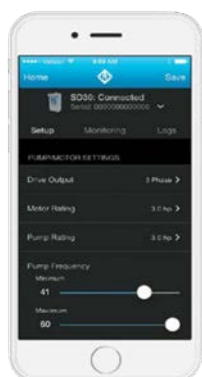

## FE CONNECT MOBILE APP

Wi-Fi connectivity is a feature of the drive that enables a connection to be made with a single Wi-Fi device (smartphone or tablet). The connection can be used to monitor drive characteristics, adjust advanced settings, and view or email fault history and configuration changes. The mobile app can be downloaded from the Apple App Store or Google Play depending on the device being used.

## Galvanized Iron Fittings & Nipples

### NIPPLES



PART #	SIZE	PRICE
FH100CNG	1" x close	\$ 3.03
FH100X2NG	1" x 2"	\$ 3.34
FH100X3NG	1" x 3"	\$ 3.91
FH100X6NG	1" x 6"	\$ 6.12
FH100X8NG	1" x 8"	\$ 11.34
FH100X10NG	1" x 10"	\$ 13.48
FH100X12NG	1" x 12"	\$ 14.90
FH150CNG	1½" x close	\$ 4.76
FH150X2NG	1½" x 2"	\$ 5.04
FH150X6NG	1½" x 6"	\$ 9.32
FH200CNG	2" x close	\$ 6.18
FH200X3NG	2" x 3"	\$ 7.54
FH200X6NG	2" x 6"	\$ 12.15

### TEE



PART #	SIZE	PRICE
FH100TG	1"	\$ 7.36
FH150TG	1½"	\$ 14.15
FH200TG	2"	\$ 21.22
FH125X1RTG	1¼" x 1"	\$ 14.78
FH150X15X1RTG	1½" x 1"	\$ 18.67
FH200X2X1RTG	2" x 1"	\$ 24.05

### 90° ELBOW



PART #	SIZE	PRICE
FH100X90EG	1"	\$ 5.66
FH150X90EG	1½"	\$ 11.32
MN200X90EG	2"	\$ 16.98

### STREET ELBOW



PART #	SIZE	PRICE
FH100X90SEG	1"	\$ 6.70
FH150X90SEG	1½"	\$ 14.33
FH200X90SEG	2"	\$ 20.24



### COUPLER

PART #	SIZE	PRICE
FH100CG	1"	\$ 4.53
FH150CG	1½"	\$ 7.79
MN200CG	2"	\$ 12.03



### UNION

PART #	SIZE	PRICE
FH100UG	1"	\$ 19.10
FH150UG	1½"	\$ 33.42
FH200UG	2"	\$ 50.91



### REDUCING COUPLER

PART #	SIZE	PRICE
FH125X1RCG	1¼" x 1"	\$ 7.31
FH150X1RCG	1½" x 1"	\$ 8.73
FH150x125RCG	1½" x 1¼"	\$ 8.73
FH200x150RCG	2" x 1½"	\$ 13.23



### INSERT X MIPT - NICKLE PLATED

PART #	SIZE	PRICE
DC100CN-PL	1"	\$ 2.70
DC125CN-PL	1¼"	\$ 3.70
DC150CN-PL	1½"	\$ 4.80
DC200CN-PL	2"	\$ 7.00

## Flow Sleeves

Use a flow sleeve for lakes, ponds, creeks and cisterns.  
\*Cement and Teflon Tape included.\*

FEFSLEEVE - \$ 145.00 net

## EZ-FLOW Fertilizer Injectors

EZ-FLO provides automatic fertilization through an irrigation system. Fertilizer feeds gently in adjustable small precision doses every time the system requires fertilization. (Liquid fertilizer can be purchased at any hardware or farm store).

PART #	SIZE	PRICE
MNEZ001CX	1.5 gal Injector Unit	\$ 570.17
MNEZ003CX	2.5 gal Injector Unit	\$ 763.89
MNEZ005-FX	5 gal Injector Unit	\$ 1,509.18
MN2662	Rid O Rust Stain Remover - 1 Gallon	\$ 17.41
MNFRR1	Rid O Rust Prevention (64oz) 2x Concentrate	\$ 38.00
MNCBVT100	1" Thread Ball Valve Coupling	\$ 59.25

\* Fertilizer Available upon Request \*



## ASSEMBLY REQUIRED TO SUIT APPLICATION



MixRite Injectors also available



\*\* Pump splice kits see page 73 \*\*



**CAST ALUMINUM PRIMING PUMP**

PART #	SIZE	PRICE
BE9-30	1" MIPT Hand Primer	\$ 190.61
BEP9-30-3	Diaphragm	\$ 40.75
BEP9-30-12	Check Valve w/Ball	\$ 24.28



**PENTEK VARIABLE FREQUENCY DRIVE (VFD)**

PART #	SIZE	PRICE
FEPID1	1HP	\$ 1,438.85
FEPID20	2HP	\$ 1,690.70
FEPID50	5HP	\$ 2,952.55



**PRESSURE / FLOW SWITCH**

PART #	SIZE	PRICE
DSFSG9J24	40-60 psi (use with pressure tank)	\$ 36.10
FEFS43	Flow Switch	\$ 195.39



**PRESSURE TANK**

PART #	SIZE	PRICE
FEPS19TT02	19 gallon capacity	\$ 312.42
FEPS35T05	35 gallon capacity	\$ 691.26



**BRASS SWING CHECK VALVES**

PART #	SIZE	PRICE
FH100BSCV	1"	\$ 21.38
FH125BSCV	1¼"	\$ 36.04
FH150BSCV	1½"	\$ 46.60
FH200BSCV	2"	\$ 76.87
FH300BSCV	3"	\$ 187.61
FH400BSCV	4"	\$ 285.54



**SURE-FLOW SUCTION SCREEN WITH SLIDE**

PART #	SIZE	PRICE
AUSFS2	2"	\$ 73.12
AUSFS3	3"	\$ 87.39
AUSFS4	4"	\$ 119.49
AUSFS5	5"	\$ 169.43
AUSFS6	6"	\$ 205.10
AUSFS8	8"	\$ 344.22
AUSFS10	10"	\$ 458.36
AUSFS12XL	12"	\$ 1,778.15



**TIGER FLEX INTAKE HOSE**

PART #	SIZE	PRICE
EGK200	2" suction hose	\$ 4.95/FT
EGW300	3" suction hose	\$ 10.49/FT
EGW400	4" suction hose	\$ 16.91/FT
EGW600	6" suction hose	\$ 32.64/FT
EGSDBC2	2" tiger-flex clamp	\$ 12.06
EGSDBC3	3" tiger-flex clamp	\$ 14.65
EGSDBC4	4" tiger-flex clamp	\$ 15.96
EGSDBC6	6" tiger-flex clamp	\$ 25.21

Sold in 5' increments, minimum 5'



**PVC FOOT VALVES**

(SPRING CHECK VALVES WITH SCREEN)

PART #	SIZE	PRICE
BA44067	1" FIPT w/screen	\$ 13.10
BA44065	1½" FIPT w/screen	\$ 19.45
BA50051	2" FIPT w/screen	\$ 23.20



**PVC CHECK VALVES (SPRING CHECK VALVES)**

PART #	SIZE	PRICE
BA43937	1" FIPT x FIPT without screen	\$ 11.07
BA43939	1½" FIPT x FIPT without screen	\$ 15.27
BA43940	2" FIPT x FIPT without screen	\$ 14.15



**SELF-CLEANING STRAINER**

PART #	SIZE	PRICE
AUSCS2	50 gpm	\$ 465.49



**GUZZLER STRAINER 2"**

PART #	SIZE	PRICE
EUGUZZLER40	40 gpm	\$ 207.00
EUGUZZLER80	80 gpm	\$ 360.00



**FLOAT SWITCH**

PART #	SIZE	PRICE
DS880NOC-20	Float Switch	\$ 72.00
DSFS2860U	Float w/10' cord	\$ 54.00

Rain Bird Pump Starts on page 44

Hunter Pump Starts on Page 57

# RAIN BIRD

## Rain Bird 17mm Drip Pipe



PRESSURE COMPENSATING LANDSCAPE DRIPLINE		COIL LENGTH	PRICE
AXXFD0912100	0.9 gph per emitter, 12" spacing, 17mm	100'	\$ 114.40
AXXFD0612100	0.6 gph per emitter, 12" spacing, 17mm	100'	\$ 114.40
AXXFD0912500	0.9 gph per emitter, 12" spacing, 17mm	500'	\$ 478.40
AXXFD0612500	0.6 gph per emitter, 12" spacing, 17mm	500'	\$ 478.40
AXXFS0612500	0.6 gph per emitter, 12" spacing, 17mm Copper Shield	500'	\$ 697.98
AXXFS0912500	0.9 gph per emitter, 12" spacing, 17mm Copper Shield	500'	\$ 697.98
AXLDQ086100	0.8 gph per emitter, 6" spacing, 1/4" OD	100'	\$ 193.58



AXXFD Fittings

## Rain Bird 17mm Drip Fittings

LANDSCAPE DRIP-LINE & DISTRIBUTION TUBING INSERT FITTINGS		BAG QTY.	PRICE
AXXFFCOUP	Rain Bird 17mm insert coupler for drip line	25	\$ 0.71
AXXFFTEE	Rain Bird 17mm insert tee for drip line	25	\$ 1.03
AXXFFELBOW	Rain Bird 17mm insert 90° elbow for drip line	25	\$ 0.93
AXXFFMA075	Rain Bird 17mm insert x 3/4" MIPT	25	\$ 1.10
AXXFFMA050	Rain Bird 17mm insert x 1/2" MIPT	25	\$ 1.03



AXXQF1012100

## Rain Bird Distribution Tubing

DISTRIBUTION TUBING		COIL LENGTH	PRICE
AXXFD100	17mm, blank distribution tubing	100'	\$ 58.30
AXXFD500	17mm, blank distribution tubing	500'	\$ 197.63
AXXQF1012100	1" Drip Header Line	100'	\$ 559.52



AXARV050

AXTDS

## Rain Bird Drip Accessories

RAIN BIRD LANDSCAPE DRIP-LINE ACCESSORIES		BAG QTY.	PRICE
AXARV050	Rain Bird air release valve for drip-line systems	1	\$ 22.81
AXTDS-6050	Xeri-stake galvanized tie down	50	\$ 0.86
AXTDS-6500	Xeri-stake galvanized tie down	500	\$ 0.83
AXXMTOOL	Rain Bird "Xeriman" emitter installation tool	1	\$ 8.80



AXTS025

AXTS025WC

AXRS-025

## Rain Bird Drip Stakes

STAKES FOR USE WITH LOW VOLUME PRODUCTS		BAG QTY	PRICE
AXTS-025	Rain Bird 1/4" tubing stake	100	\$ 1.12
AXTS-025WC	Rain Bird 1/4" tubing stake with bug cap	100	\$ 1.08
AXRS-025	Rain Bird stake for poly-flex riser, stake by 10/32" MIPT	25	\$ 2.28



AXPFR-12

AXPFRS

## RAIN BIRD LOW VOLUME RISERS (FOR CONNECTING MICRO-SPRAYS AND OTHER EMISSION DEVICES TO FITTINGS)

		BAG QTY	PRICE
AXPFR-12	Rain Bird 12" poly-flex riser, accepts 10/32" thread emission devices	25	\$ 0.85
AXPFR-RS	Rain Bird 12" poly-flex riser assembly, 12" poly-flex riser on stake with 1/4" insert inlet	250	\$ 3.18



AXMD075MA

AXMDCFCAP

AXMDCOUP

## MULTI DIAMETER COMPRESSION FITTINGS

		BAG QTY.	PRICE
AXMD05MA	Multi-diameter fitting comp x MPT 1/2" adapter	20	\$ 2.55
AXMD075MA	Multi-diameter fitting comp x MPT 3/4"	20	\$ 2.55
AXMDCFCAP	Multi-diameter flush cap, inserts into compression fitting	20	\$ 1.96
AXMDCOUP	Multi-diameter fitting comp x comp coupler	20	\$ 3.26
AXMDEL	Multi-diameter fitting comp x comp elbow	20	\$ 3.82
AXMDTEE	Multi-diameter fitting comp x comp tee	10	\$ 4.87



AXMDEL

AXMDTEE

## Rain Bird Zone Control

CONTROL ZONE KITS - VALVE, FILTER & PRESSURE REGULATION COMBO		PRICE
AXXCZ-075	Rain Bird, low-flow, control zone kit, 3/4" FIPT inlet x 3/4" MIPT outlet	\$ 156.77
AXXCZ-100	Rain Bird 1" control zone kit, 1" FIPT inlet x 1" MIPT outlet	\$ 156.79
AXXCZ100-BCOM	Rain Bird 1" commercial control zone kit, 1" FIPT	\$ 659.78



XCZ ZONE KIT

XCZ-BCOM





## Hunter 17mm Dripline & Fittings

HUNTER HDL DRIPLINE		COIL LENGTH	PRICE
PDHDL0612250PC	0.6 gph per emitter, 12" spacing, 17mm	250'	\$ 196.96
PDHDL0912250PC	0.9 gph per emitter, 12" spacing, 17mm	250'	\$ 196.96



17mm Drip Fittings



LANDSCAPE DRIP-LINE & DISTRIBUTION TUBING INSERT FITTINGS		BAG QTY.	PRICE
PDPLD050	17mm insert x 1/2" MIPT male adapter, Hunter	25	\$ 1.21
PDPLD075	17mm insert x male adapter 3/4" MIPT, Hunter	25	\$ 1.26
PDPLDTEE	17mm insert tee, Hunter	25	\$ 1.16
PDPLDELB	17mm insert elbow, Hunter	25	\$ 0.90
PDPLDCPL	17mm insert coupler for drip line, Hunter	25	\$ 0.81
PDPLDBV	17mm barb x barb manual shut off valve, Hunter	25	\$ 5.69



Control Zone Kit

## Hunter Zone Control

CONTROL ZONE KITS - VALVE, FILTER & PRESSURE REGULATION COMBO		PRICE
PDP CZ101	Hunter 1" control zone kit, 1" FIPT inlet x 1" FIPT outlet	\$ 154.88

## Netafim 17mm Dripline



NETAFIM LANDSCAPE TECHLINE		COIL LENGTH	PRICE
ATTLDL0912100	0.9 gph per emitter, 12" spacing, 17mm	100'	\$ 85.30
ATTLDL0612100	0.6 gph per emitter, 12" spacing, 17mm	100'	\$ 85.30
ATTLDL0912500	0.9 gph per emitter, 12" spacing, 17mm	500'	\$ 426.50
ATTLDL0612500	0.6 gph per emitter, 12" spacing, 17mm	500'	\$ 426.50



ATTL075MA    ATTLCOUP    ATTLCROS



ATTLLELL    ATTLTEE

## Netafim 17mm Insert Fittings (Techline)

NETAFIM TECHLINE FITTINGS		BAG QTY.	PRICE
ATTL075MA	17mm insert x 3/4" MIPT Adapter	25	\$ 1.10
ATTLCOUP	17mm insert coupler	25	\$ 0.70
ATTLCROS	17mm insert cross	25	\$ 1.70
ATTLLELL	17mm insert elbow	25	\$ 0.95
ATTLTEE	17mm insert tee	25	\$ 1.00



ATEDTUBE10



ATEDTUBE8MXT

## Netafim Micro Tubing

NETAFIM 1/4" TUBING & FITTINGS		PRICE
ATEDTUBE01	1/4" x 100' Micro Tubing	\$ 12.75
ATEDTUBE10	1/4" x 1000' Micro Tubing	\$ 127.00
ATEDTUBE8MXT	1/2" MPT x 8 Way 1/4" Tubing Adapter	\$ 2.28
ATEDTUBEBA	1/4" Micro Tubing Coupler	\$ 0.32
ATEDTUBETEE	1/4" Micro Tubing Tee	\$ 0.41



ATEDTUBETEE



ATEDTUBEBA

## Rain Bird Low Volume Bubblers



BUBBLERS & ADJUSTABLE MICRO-BUBBLERS		BAG QTY.	PRICE
AXSXB-180	Rain Bird 180° adjustable micro-bubbler x 10/32" thread	20	\$ 2.56
AXSXB-360	Rain Bird 360° adjustable micro-bubbler x 10/32" thread	20	\$ 2.56
AXSXB-360-025	Rain Bird 360° adjustable micro-bubbler x 1/4" insert	20	\$ 2.56
AXSXB-180SPYK	Rain Bird 180° adjustable micro-bubbler x spike	10	\$ 3.06
AXSXB-360SPYK	Rain Bird 360° adjustable micro-bubbler x spike	10	\$ 3.06
AX1404	Bubbler fixed flow 1.0 gpm, 1/2" FIPT Rain Bird	25	\$ 13.15
AX1402	Bubbler fixed flow 0.5 gpm, 1/2" FIPT Rain Bird	25	\$ 13.15
AX1401	Bubbler fixed flow 0.25 gpm, 1/2" FIPT Rain Bird	25	\$ 13.15
AX1300AF	Bubbler adjustable flow 1.0 - 2.5 gpm, 1/2" FIPT Rain Bird	25	\$ 3.17



AXXQ100

## Rain Bird 1/4" Distribution Tubing & Fittings

LOW VOLUME 1/4" DISTRIBUTION TUBING		ROLL	PRICE
AXXQ1000B	Xeri-Tubing distribution tubing bucket	1000'	\$ 152.83
AXXQ100	Poly 1/4" distribution tubing 100'	100'	\$ 16.04



AXXBF1

AXXBF3

AXXBF2

LOW VOLUME 1/4" DISTRIBUTION FITTINGS & ACCESSORIES		BAG QTY.	PRICE
AXXBF1	Rain Bird 1/4" insert coupling	50	\$ 0.35
AXXBF2	Rain Bird 1/4" insert 90° elbow	50	\$ 0.44
AXXBF3	Rain Bird 1/4" insert tee	50	\$ 0.55

## Rain Bird Drip Emitters



AXXB-05

AXPC Module

AXXBT-10

AXPCDIFF

MICRO IRRIGATION LOW VOLUME EMISSION DEVICES		BAG QTY.	PRICE
AXSPB-025	Rain Bird self piercing connector (grey) Non pressure regulated emitter	25	\$ 0.92
AXXB-05	Rain Bird self piercing 0.5 gph emitter (blue)	100	\$ 1.07
AXXB-10	Rain Bird self piercing 1.0 gph emitter (black)	100	\$ 1.07
AXXB-20	Rain Bird self piercing 2.0 gph emitter (red)	100	\$ 1.07
AXXBT-10	Rain Bird 1/2" FIPT 1.0 gph emitter	20	\$ 5.08
AXXBT-20	Rain Bird 1/2" FIPT 2.0 gph emitter	20	\$ 5.08
AXPC-10	Rain Bird 10 gph pressure compensating module (green)	10	\$ 3.03
AXPC-12	Rain Bird 12 gph pressure compensating module (dark brown)	10	\$ 3.03
AXPC-18	Rain Bird 18 gph pressure compensating module (white)	10	\$ 3.03
AXPC-24	Rain Bird 24 gph pressure compensating module (orange)	10	\$ 3.03
AXPCDIFF	Rain Bird emitter diffuser cap (snaps on the emitter)	50	\$ 0.28
AXPCDBC025	Rain Bird emitter diffuser cap (barb insert for the end of 1/4" line)	50	\$ 0.85

## Rain Bird Low Volume Sprays



AXXS090

AXXS180

AXXS360

ADJUSTABLE MICRO-SPRAYS		BAG QTY.	PRICE
AXXS-090	Rain Bird 90° adjustable micro-spray x 10/32" thread	10	\$ 4.84
AXXS-180	Rain Bird 180° adjustable micro-spray x 10/32" thread	10	\$ 4.84
AXXS-360	Rain Bird 360° adjustable micro-spray x 10/32" thread	10	\$ 4.84
AXXS-360SPYK	Rain Bird 360° adjustable micro-spray x spike	10	\$ 3.16
AXXMISTADJ	Rain Bird 360° adjustable micro-mister x 10/32" thread	20	\$ 6.22



AX1800 RETRO

RETROFIT SPRAY	PRICE
AX1800RETRO	Rain Bird 4" 1800 body with 30 psi pressure regulator, 200 mesh filter, 1/2" FIPT x 1/2" MIPT \$ 65.52

## Rain Bird Xeri-Pop



AXXP600

AXXP400

AXXPCN nozzle

XPCN SERIES NOZZLES		BAG QTY.	PRICE
AXXP400	4" Xeri-Pop	5	\$ 14.27
AXXP600	6" Xeri-Pop	5	\$ 21.39
AXXPCNQ	Quarter pattern, fits on spray head or XPCN adapter	25	\$ 6.51
AXXPCNH	Half pattern, fits on spray head or XPCN adapter	25	\$ 6.51
AXXPCNF	Full pattern, fits on spray head or XPCN adapter	25	\$ 6.51
AXSQADP12	SQ12" PFR Assembly Adapter	25	\$ 3.04



## Drip Parts and Accessories



AXXBD80  
AXXBD81



AXEMT6X



AX1032A



AXXBA-1800

### Rain Bird Drip Manifolds

DRIP MANIFOLDS AND ADAPTERS		BAG QTY.	PRICE
AXXBD-80	Rain Bird 8 way multi-outlet drip manifold (outlets come sealed, out of the box) x 1/2" FIPT	1	\$ 47.61
AXXBD-81	Rain Bird 8 way multi-outlet drip manifold with 1 gph drip emitters installed x 1/2" FIPT	1	\$ 63.87
AXEMT-6X	Rain Bird 6 way multi outlet drip x 1/2" FIPT	10	\$ 11.10
AX1032A	1/2" FIPT x 10/32 thread riser x xeri adapter	25	\$ 2.23
AXXBA-1800	Spray head x 10/32 xeri adapter	25	\$ 3.44



OR67000



OR67005



OR67050



OR63035

### Orbit Manifolds

DRIP MANIFOLDS AND ADAPTERS		BAG QTY.	PRICE
OR67000	8 way drip manifold x 1/2" FIPT (61008)	1	\$ 21.25
OR67005	4 way adjustable drip manifold x 1/2" FIPT (61006)	1	\$ 17.41
OR63035	2 way drip manifold x 1/2" FIPT (61005)	40	\$ 4.14
OR67050	1/2" FIPT x 1/2" MIPT with 90° 1/4" elbow to accept distribution tubing (61010)	30	\$ 4.18

### Orbit Drip Accessories

LOW VOLUME 1/4" DISTRIBUTION FITTINGS & ACCESSORIES		BAG QTY.	PRICE
OR65715	1/4" tubing clips (MC025)	25	\$ 0.53
OR61800	Xeri kit for 1/4" xerigation, 92 piece	1	\$ 21.94
OR67404	1/4" In-Line Valve	5	\$ 1.27



ECO-ID



AT11-07737



AA700AP8



AA700-CETC

Parts Discount

### Stakes & Fittings

USE WITH LOW VOLUME PRODUCTS		BAG QTY.	PRICE
ORPCS12	12" stake for use with PSA-1032	25	\$ 1.41
ORPSA1032	1/4" insert x 10/32" FIPT for use with PCS-12	25	\$ 0.98
OR69115	Micro spray strip 10-32 thread adjustable	2	\$ 6.20
AT11-07737	Goof or mistake plug	20	\$ 0.06
AA700-AP8	Figure 8 end closure	50	\$ 0.37
AA700-CETC	Flush end-cap	25	\$ 1.76
AT10F01	System Indicator Flag for Drip Systems	10	\$ 9.27
MRSW6	NDS Drip Stake	25	\$ 0.29
PDECO-ID	Eco Indicator	10	\$ 24.80



### Tree Diapers

TREE DIAPERS		PRICE
OGTD24	24" Round Tree Diaper for 1.5" tree	\$ 35.00
OGTD36	36" Round Tree Diaper for 3" tree	\$ 53.50



DRIP-LOCK FITTINGS		BAG QTY.	PRICE
OR07490	1/2" Elbow	25	\$ 4.26
OR07491	1/2" Coupling	25	\$ 4.26
OR07492	1/2" Tee	25	\$ 7.19
OR07493	1/2" x 3/4" Adapter	25	\$ 3.21
OR07494	1/2" Adapter	25	\$ 2.94
OR07495	1/2" x 5/8" Adapter	25	\$ 3.74
OR07497	1/2" Valve Shut Off	25	\$ 7.41
OR07498	1/2" x MHT End Cap	25	\$ 3.98

## Large Capacity Y-Filters

These filters provide large filtration capacity for residential, commercial, and municipal drip applications. The filter body and cover are made of high impact thermal plastic, rated to withstand water up to 140° F (60° C) and pressures up to 116 psi (8 bar).



### Rain Bird Filters

FILTERS	DESCRIPTION	PRICE
AXLCRBY100D	1" Large Capacity in-line Disc Filter	\$ 85.52
AXLCRBY150D	1½" Large Capacity in-line Disc Filter	\$ 195.31
AXLCRBY200D	2" Large Capacity in-line Disc Filter	\$ 263.92
AXLCRBY075S	¾" Large Capacity in-line Screen Filter	\$ 42.80
AXLCRBY150S	1½" Large Capacity in-line Screen Filter	\$ 142.51
AXLCRBY200S	2" Large Capacity in-line Screen Filter	\$ 212.26



PFR

PSI

### Rain Bird Filters & Pressure Regulation

INLINE PRESSURE REGULATING FILTERS		PRICE
AXPRF075	Rain Bird ¾" MIPT, 30 psi integrated pressure regulator 30 - 300 gph, 200 mesh screen	\$ 92.36
AXPRF100	Rain Bird 1" MIPT, 40psi integrated pressure regulator 180 - 900 gph, 200 mesh screen	\$ 107.55

PRESSURE REGULATORS		PRICE
AXPSIHLA	Rain Bird ¾" FIPT, 30 psi, low flow, 6 - 300 gph	\$ 47.13
AXPSIHMA	Rain Bird ¾" FIPT, 30 psi, med flow, 120 - 600 gph	\$ 47.87



RBY

FILTERS	DESCRIPTION	PRICE
AXRBY075	Rain Bird ¾", MIPT, with 200 mesh screen - for drip	\$ 51.39
AXRBY100	Rain Bird 1", MIPT, with 200 mesh screen - for drip	\$ 52.86

INDICATORS		PRICE
AXOPERIND	Drip Operation Indicator	\$ 24.96



¾" & 1" Jain Filter

### Jain Spin Clean Plastic Filters

FILTERS	DESCRIPTION	PRICE
AA4E075B150	Screen, 150 Mesh, ¾" MIPT x MIPT, 13 Max GPM	\$ 47.50
AA4E1B050	Screen 50 Mesh, 1" MIPT x MIPT, 31 Max. GPM	\$ 47.02
AA4E1B150	Screen 150 Mesh, 1" MIPT x MIPT, 31 Max. GPM	\$ 47.02
AA4E15B030	Screen 30 Mesh, 1½" MIPT x MIPT, 53 Max GPM	\$ 530.29
AA4E15B050	Screen 50 Mesh, 1½" MIPT x MIPT, 53 Max. GPM	\$ 530.29
AA4E2P030	Screen 30 Mesh, 2" MIPT x MIPT, 110 Max. GPM	\$ 583.32
AA4E2P050	Screen 50 Mesh, 2" MIPT x MIPT, 110 Max. GPM	\$ 583.32
AA4E2P150	Screen 150 Mesh, 2" MIPT x MIPT, 110 Max. GPM	\$ 583.32



1 ½" & 2" Jain Filter



# Disc and Screen Filters



## Amiad Filter Elements

Colour	Mesh	Micron
Screen		
Gray	20	800
Green	30	500
Blue	50	300
White	75	200
Red	120	130
Yellow	155	100
Black	200	80
Discs		
Red	120	130
Black	155	100

### Understanding Mesh vs. Micron:

Mesh size refers to the mesh number and its relationship to the size of the openings in the mesh, it accounts for the size of particles that can pass through these openings. Micron is a measurement term frequently used to describe tiny particle sizes. It is equal to one-millionth of a meter or about one twenty-five thousandth of an inch.

## Amiad Plastic Filters

FILTERS	DESCRIPTION	SIZE	MAX. GPM	PRICE
AC101-0059-120	Screen, 120 Mesh	3/4" MIPT	13	\$ 46.82
AC101-0059-155	Screen, 155 Mesh	3/4" MIPT	13	\$ 46.82
AC101-0059-200	Screen, 200 Mesh	3/4" MIPT	13	\$ 46.82
AC112-0054-120D	Disc, 120 Mesh	1" MIPT	31	\$ 119.05
AC112-0054-155D	Disc, 155 Mesh	1" MIPT	31	\$ 119.05
AC112-0059-120	Screen, 120 Mesh	1" MIPT	31	\$ 113.70
AC112-0059-155	Screen, 155 Mesh	1" MIPT	31	\$ 113.70
AC112-0059-200	Screen, 200 Mesh	1" MIPT	31	\$ 113.70
AC115-0054-120D	Disc, 120 Mesh	1½" MIPT (short)	35	\$ 157.84
AC116-0054-120D	Disc, 120 Mesh	1½" MIPT	66	\$ 246.12
AC116-0054-155D	Disc, 155 Mesh	1½" MIPT	66	\$ 246.12
AC116-0059-120	Screen, 120 Mesh	1½" MIPT	66	\$ 236.76
AC116-0059-155	Screen, 155 Mesh	1½" MIPT	66	\$ 236.76
AC116-0059-200	Screen, 200 Mesh	1½" MIPT	66	\$ 236.76
AC122-0054-120D	Disc, 120 Mesh	2" MIPT	80	\$ 477.53
AC122-0054-155D	Disc, 155 Mesh	2" MIPT	80	\$ 477.53
AC122-0059-120	Screen, 120 Mesh	2" MIPT	80	\$ 477.53
AC122-0059-155	Screen, 155 Mesh	2" MIPT	80	\$ 477.53
AC126-0054-120D	Disc, 120 Mesh	2" Super MIPT	110	\$ 568.49
AC126-0054-155D	Disc, 155 Mesh	2" Super MIPT	110	\$ 568.49
AC126-0059-030	Screen, 30 Mesh	2" Super MIPT	110	\$ 568.49
AC126-0059-155	Screen, 155 Mesh	2" Super MIPT	110	\$ 568.49
AC126-0059-200	Screen, 200 Mesh	2" Super MIPT	110	\$ 605.94



3/4" Filter



1" Filter



1 1/2" Filter



2" Filter



2" Super Filter

2" In-Line Steel Filter



4" In-Line Steel Filter

## Amiad Steel Filters

FILTERS	DESCRIPTION	SIZE	MAX. GPM	PRICE
AC2030011107-155	Disc, 155 Mesh	3" Flanged	220	\$ 1,570.22
AC2040011101-155	Screen, 155 Mesh	4" Flanged	350	\$ 2,689.96
AC206001110-155	Screen, 155 Mesh	6" Flanged	700	\$ 4,487.73



Kifco Water-Reels® are compact and very easy to maneuver, they operate unattended and are equipped with a uniquely powered automatic shut down system which operates at the completion of each run.

## Kifco Water~Reel Irrigation Systems

### Features:

- Require far less labour than conventional reel systems
- Often can be operated from a municipal water supply without the need for a pump
- Optional booster pump for low pressure situations. Please ask your Vanden Bussche Representative for booster pump pricing
- Compact and highly mobile
- Economical

## Portable • Reliable • Simple • Automatic • Affordable

### Machine Selection

Consider these questions when thinking about machine selection:

- Is your application turf or agriculture?
- What is the size of the area to be irrigated, length & width?
- What is the irrigation cycle? (The frequency at which water is to be applied)
- How much water do you want to apply?
- What is your water source? Well, Municipal or other?
- What is your pressure (psi) and flow (gallons per minute, gpm)?
- What is your budget? To minimize labour and irrigation time, select the largest machine that fits your budget.



All Kifco Water-Reels® offer adjustable speed control to regulate run time and application depth and feature automatic retraction and sprinkler shutdown.

Kifco Water-Reels® will automatically stop when the sprinkler cart arrives at the machine. The operator can select the speed of rewind which determines the amount of water applied to the site.

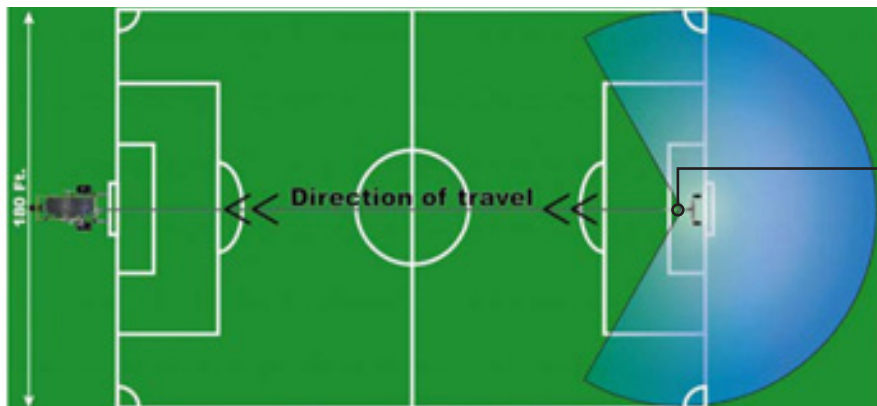

\*Contact Vanden Bussche Irrigation for specifications & price.

## Kifco Water-Reel Irrigation Systems

Model	Tube Inner Diameter / Length	Irrigated Width	Irrigated Length	Irrigated Area (Acres)	Drive System	GPM Range	Inlet PSI Range	Booster Pump Options
B110	1.1/280	79'-115'	319'-338'	0.6-0.9	Bellows	10-33	50-113	Electric
B140	1.4/350	120'-160'	410'-440'	6-15	Bellows	25-60	45-117	5Hp/9Hp
T180	1.8/380	125'-180'	449'-478'	6-24	Turbine*	25-102	50-150	5Hp/9Hp
T200S	2.0/320	148'-218'	394'-435'	6-34	Turbine*	25-143	50-150	5Hp/9Hp
E200SST**	2.0/320	132'-170'	384'-401'	N/A	Engine	80-160	68-148	5Hp/9Hp
T200L	2.0/580	138'-191'	649'-676'	11-30	Turbine*	47-125	55-140	5Hp/9Hp
T200LSC***	2.0/580	138'-191'	649'-676'	11-30	Turbine	47-125	N/A	23Hp
T210	2.1/400	154'-218'	477'-509'	11-30	Turbine*	47-125	55-140	5Hp/9Hp

### Machine Model Numbers

Machine model numbers provide information about the type of machine, B-bellows, T-turbine, E-engine, the inside diameter (I.D.) of the tube and the length of the tube in feet. For example: a T-200/320 is a turbine machine with an inside tube diameter of 2" and a tube length of 320', an E40A/1320 is an engine driven machine with an inside tube diameter of 4" and a tube length of 1320'.



# SHINE A LIGHT ON **VALUE**



*An up light to add texture, contrast, and depth*



*A wall wash to highlight stonework or architecture*



*A path light to boost ambience and safety*

*Versatility, elegance, and affordability merge seamlessly with the FX Luminaire Value Line.*

Taken together, the RS, WS, and SP-A fixtures offer a cost-effective, system-level lighting solution backed by the superior performance synonymous with our name. The corrosion-resistant aluminum fixtures are available in a range of finishes to complement any outdoor space.





**Up Lights**

PART #	MATERIAL/COLOUR	LAMP TYPE	LAMP INCLUDED	PRICE
PDMUNLLSFB	Alum. Flat Black	MR-16	No	\$ 172.61
PDMUNLLSBZ	Alum. Bronze Metallic	MR-16	No	\$ 172.61
PDRSNLLSFB	Alum. Flat Black	MR-16	No	\$ 147.02
PDRSNLLSBZ	Alum. Bronze Metallic	MR-16	No	\$ 147.02



**Wash Light**

PART #	MATERIAL/COLOUR	LAMP TYPE	LAMP INCLUDED	VA	PRICE
PDWSLED35WFB	Alum. Flat Black	G4 Bi-Pin LED	LED	2.6	\$ 202.91

PDWSLED35WFB

**Risers & Elbows**

PART #	MATERIAL/COLOUR	DESCRIPTION	PRICE
PD18RFB	Alum. Flat Black	18" Risers	\$ 49.65
PD18RBZ	Alum. Bronze	18" Risers	\$ 49.65
PDELBW050FB	Alum. Flat Black	90 Degree Elbow	\$ 38.19
PDELBW050BZ	Alum. Bronze	90 Degree Elbow	\$ 38.19



**Path Lights**

PART #	MATERIAL/COLOUR	LAMP TYPE	LAMP INCLUDED	PRICE
PDPLNL18RFB	PL Path Light - 18" Flat Black	G4 Bi-Pin	No	\$ 223.31
PDPLNL18RBZ	PL Path Light - 18" Bronze Metallic	G4 Bi-Pin	No	\$ 223.31
PDDMNL18RFB	DM Path Light - 18" Flat Black	G4 Bi-Pin	No	\$ 372.16
PDDMNL18RCU	DM Path Light - 18" Copper	G4 Bi-Pin	No	\$ 380.60



PDPLNL18R

PDDMNL18R

**Down Lights**

PART #	MATERIAL/COLOUR	LAMP TYPE	LAMP INCLUDED	PRICE
PDCDLNLAB	Antique Bronze	MR-16	No	\$ 265.32
PMDNLF	Alum. Flat Black	MR-16	No	\$ 235.01
PMDNLBZ	Alum. Bronze	MR-16	No	\$ 235.01



PMDNLFB

PMDNLBZ

PDCDLNLAB

**Mounting Options**

PART #	MATERIAL/COLOUR	DESCRIPTION	PRICE
PDTBFB	Alum. Flat Black	Tree Box for up to 2 fixtures	\$ 74.44
PDWMFB	Alum. Flat Black	Wall Mount with Knuckle	\$ 47.71
PDMJ05FB	Alum. Flat Black	Mini J-Box for 1/2" Thread	\$ 57.00
PDMM050FB	Alum. Flat Black	Mini Mount 1/2"	\$ 37.00
PDMM050BZ	Alum. Bronze	Mini Mount 1/2"	\$ 37.00



PDTBFB

PDWMFB

PDMJ05FB

PDMM050BZ

**Wall Lights**

PART #	MATERIAL/COLOUR	LAMP TYPE	LAMP INCLUDED	PRICE
PDMM10FB	Alum. Flat Black	Bi-Pin	Yes	\$ 202.83
PDTCNLCU	Casa Copper	AR-11	No	\$ 410.01
PDTCNLFB	Flat Black	AR-11	No	\$ 430.02

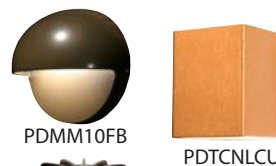

PDMM10FB

PDTCNLCU

**Well Lights**

PART #	MATERIAL/COLOUR	LAMP TYPE	LAMP INCLUDED	PRICE
PDRPNLLVCB	Camo Bronze	MR-16	No	\$ 375.02
PDFCNLRGCB	Camo Bronze	MR-11	No	\$ 188.94



PDRPNLLVCB

PDFCNLRGCB





## The intersection of art & engineering Integrated LED Fixtures

\*\* - LUXOR TRANSFORMER REQUIRED  
PAGE 99



### Up Lights

PART #	MATERIAL/COLOUR	LAMP INCLUDED	LAMP TYPE	VA	PRICE
PDFB3LEDFB	Flat Black	3 LED	Integrated	4.5	\$ 341.66
**PDNPZDCFB	Alum. Flat Black	Colour	Integrated	11.0	\$ 785.01



### Wall Wash Lights

PART #	MATERIAL/COLOUR	LAMP INCLUDED	LAMP TYPE	VA	PRICE
PDPB3LEDFB	Flat Black	3 LED	Integrated	4.5	\$ 415.02



### Step Lights

PART #	MATERIAL/COLOUR	LAMP INCLUDED	LAMP TYPE	VA	PRICE
PDLF1LEDCU	Copper	1 LED	Integrated	2.5	\$ 246.22
PDLF1LEDFB	Flat Black	1 LED	Integrated	2.5	\$ 235.01



### Path Lights

PART #	MATERIAL/COLOUR	LAMP INCLUDED	LAMP TYPE	VA	PRICE
PDMPL1LEDFB	Alum. Flat Black	1 LED	Integrated	2.4	\$ 469.65
PDMPZ1LEDFB	Flat Back	1 LED	Integrated	2.4	\$ 481.69
PDPM3LEDXTFB	Flat Black/18½" Height	3 LED	Integrated	4.5	\$ 610.00



### Wall Light

PART #	MATERIAL/COLOUR	LAMP INCLUDED	LAMP TYPE	VA	PRICE
PDPO1LEDSTFB	Flat Black	1 LED	Integrated	2.5	\$ 410.33

The intersection of art & engineering  
Integrated LED Fixtures



### ZD & ZDC LUXOR SYSTEMS



PPLSAT300M

PDLUX

#### LUXOR Transformers

PART #	DESCRIPTION	WATTS	PRICE
PDLUX150M	Matte Grey LUXOR Transformer	150	\$ 2,574.65
PDLUX300M	Matte Grey LUXOR Transformer	300	\$ 2,800.02
PPLSAT300M	LUXOR Satellite	N/A	\$ 1,944.69

#### LUXOR Accessories

PART #	DESCRIPTION	PRICE
PDWIFIMOD2	Wifi Module w/Antenna	\$ 540.33
PDLUXLAM	Light Assignment Module for Smart Phone Programming	\$ 235.01
PDLUXFPM	LUXOR Facepack Mount	\$ 55.34
PDSURGEMOD	Surge Protection for LED Fixtures	\$ 57.00



PDWIFIMOD2



PDLUX-LAM



PDSURGE-MOD

#### LUXOR MR-16 Drop-in Lamps

PART #	OUTPUT EQUIVALENT	COLOUR TEMP.	BEAM	PRICE
PDMR16ZD20WFL	20 Watt	2700K	35 deg.	\$ 143.14
PDMR16ZD35WFL	35 Watt	2700K	35 deg.	\$ 155.01
PDMR16ECOWFL	6 Watt	2700K	35 deg	\$ 52.46
PDMR16ECO50WWF	6 Watt	2700K	60 deg	\$ 36.32



PDMR-16



PDMR-16ECO

\*ZD Luxor LED Drop-in lamps require a Luxor Transformer

#### Luxor CUBES

PART #	OUTPUT EQUIVALENT	MAX. POWER	PRICE
PDLCLMLV	Low Voltage	60W / 5A	\$ 233.22
PDLCLMHV	High Voltage	400W / 3.3A	\$ 233.22



LUXOR CUBES

To learn more visit [fxl.com](http://fxl.com)

Stay up to date on events, products, and the latest news

# Connect with us!





# bt family does it all.

• Change Color from Warm White to Cool White

• Dim

• Group

• Change RGB Colors

• Create Custom Scenes for Holidays and Events

## bt products available:

- Up Lights
- Down Lights
- Flood Lights
- Area Lights
- Ground Lights
- Step Lights

*Follow the Leader*

# ALLIANCE

OUTDOOR LIGHTING

Since 2006

BUY FROM THE SOURCE



**BL400-bt**  
bt Bullet Light



**bt-RE**  
bt Range Extender

**Install a bt-RE  
on every bt Job  
and get your  
fixtures talking!**

Established 1954  
**VANDEN BUSSCHE**  
IRRIGATION

## ALLIANCE OUTDOOR LIGHTING



MIBL300



MIBL200

### LED Integrated Bluetooth Colour Bullet Lights

PART #	MATERIAL/COLOUR	LAMP INCLUDED	LAMP TYPE	MAX. WATT.	PRICE
MIBL200BT	Brass	Yes	Integrated	7	\$ 366.99
MIBL300BT	Brass	Yes	Integrated	7	\$ 545.07



MIFL50-BT

### Flood Lights

PART #	MATERIAL/COLOUR	LAMP INCLUDED	LAMP TYPE	MAX. WATT.	PRICE
MIFL50-BT	Brass	Yes	G4/BIpin	3	\$ 348.40



MIGL100-BT



MIGL150-BT

### Inground Well Lights

PART #	MATERIAL/COLOUR	LAMP INCLUDED	LAMP TYPE	MAX. WATT.	PRICE
MIGL100-BT	Brass	Yes	MR-16	6	\$ 410.27
MIGL150-BT	Brass	Yes	MR-16	6	\$ 411.30



MIDL200-BT

### Down Lights

PART #	MATERIAL/COLOUR	LAMP INCLUDED	LAMP TYPE	MAX. WATT.	PRICE
MIDL200-BT	Brass	Yes	MR-16	6	\$ 441.99



MIALSTEM-18-BT

### Area Light Storm

PART #	MATERIAL/COLOUR	LAMP INCLUDED	LAMP TYPE	MAX. WATT.	PRICE
MIALSTEM18-BT	Brass	Yes	LBIPIN	2.5	\$ 327.61

\* Refer to page 102 for compatible Alliance AI hats.



MIPL100-BT

### Path Light

PART #	MATERIAL/COLOUR	LAMP INCLUDED	LAMP TYPE	MAX. WATT.	PRICE
MIPL100-BT	Brass	Yes	G4/BIpin	2.5	\$ 436.80



MIUL100-BT

### Under Water Light

PART #	MATERIAL/COLOUR	LAMP INCLUDED	LAMP TYPE	MAX. WATT.	PRICE
MIUL100-BT	Brass	Yes	MR-16	2.5	\$ 512.00



MIBT-RE

### Accessories

PART #	DESCRIPTION	PRICE
MIBTRE	Bluetooth Range Extender for BL200-BT	\$ 148.92



Unless specified as "Integrated LED"  
Lamps are not included in any Alliance Lighting Fixtures, please refer to page 106-108  
for our selection of Lamps.



### Area Light - Hat Only

PART #	MATERIAL/COLOUR	HAT SIZE	PRICE
MIAL100	Brass - Hat Only	6.75"	\$ 84.19
MIAL150	Brass - Hat Only 10/box	6.25"	\$ 99.50
MIAL300	Brass - Triangle Hat Only	6.25"	\$ 123.28
MIAL550	Brass - Hat Only	3.5"	\$ 52.06
MIAL700	Brass - Hat Only	8.5"	\$ 207.02



### Area Light - Stems Only

PART #	MATERIAL/COLOUR	LAMP INCLUDED	LAMP TYPE	MAX. WATT.	LED READY	PRICE
MIALSTEM12	Brass - 12"	No	Bi-Pin	35	Yes	\$ 147.87
MIALSTEM18	Brass - 18"	No	Bi-Pin	35	Yes	\$ 160.33
MIALSTEMADJ	Brass - Adjustable (18" - 29")	No	Bi-Pin	35	Yes	\$ 246.28



### Path Lights

PART #	MATERIAL/COLOUR	LAMP INCLUDED	LAMP TYPE	MAX. WATT.	LED READY	PRICE
MIPL100	Brass	No	Bi-Pin	35	Yes	\$ 287.63
MIPL200	Brass	No	Bi-Pin	35	Yes	\$ 292.85
MIPL250	Brass	No	Bi-Pin	35	Yes	\$ 263.49
MIGOLF100	Brass	No	Bi-Pin		Yes	\$ 355.97



### Bullet Lights

PART #	MATERIAL/COLOUR	LAMP INCLUDED	LAMP TYPE	MAX. WATT.	LED READY	PRICE
MIBL50	Brass	No	MR-11	35	Yes	\$ 137.55
MIBL110	Brass	No	MR-16	50	Yes	\$ 161.15
MIBL200	Brass	No	MR-16	50	Yes	\$ 198.91
MIBL205	Brass/ 18" lead	No	MR-16	50	Yes	\$ 149.34
MIBL900LED5W	Brass	No	MR-16	50	Yes	\$ 240.69
MIBL300LED8W	Brass	Yes	PAR-36 LED	8	Yes	\$ 470.46

# ALLIANCE

OUTDOOR LIGHTING

Unless specified as "Integrated LED"  
Lamps are not included in any Alliance Lighting Fixtures, please refer to page 106-108  
for our selection of Lamps



### Down Lights/ Tree Lights

PART #	MATERIAL/ COLOUR	LAMP INCLUDED	LAMP TYPE	MAX. WATT.	LED READY	PRICE
MIDL50	Brass	No	MR-11	35	Yes	\$ 171.74
MIDL100	Brass	No	MR-16	50	Yes	\$ 231.35
MIDL200	Brass	No	MR-16	50	Yes	\$ 274.00



### Step/Deck Lights

PART #	MATERIAL/ COLOUR	LAMP INCLUDED	LAMP TYPE	MAX. WATT.	LED READY	PRICE
MISL25LED	Brass	Integrated	4.5 watts	n/a	n/a	\$ 208.74
MISL35LED	Brass	Integrated	9.0 watts	n/a	n/a	\$ 272.70
MISL75LED	Brass	Integrated	3.0 watts	n/a	n/a	\$ 174.29
MISL85LED	Brass	Integrated	4 watts	n/a	Yes	\$ 278.47
MISL100	Brass	No	Bi-Pin	20	Yes	\$ 162.49



### Flood Lights

PART #	MATERIAL/COLOUR	LAMP INCLUDED	LAMP TYPE	MAX. WATT.	LED READY	PRICE
MIFL50	Brass	No	Bi-Pin	20	Yes	\$ 186.14
MIFL100	Brass	No	Bi-Pin	20	Yes	\$ 199.98
MIFL200	Brass	No	MR-16	35	Yes	\$ 355.27



### In Ground/Well Lights

PART #	MATERIAL/COLOUR	LAMP INCLUDED	LAMP TYPE	MAX. WATT.	LED READY	PRICE
MIWL300	Brass	No	MR-16	50	Yes	\$ 385.22
MIGL100	Brass	No	MR-16	50	Yes	\$ 246.89
MIGL150	Brass	No	MR-16	50	Yes	\$ 246.89
**MIGL300	Brass/Composite	No	MR-16	50	Yes	\$ 159.40
MIGL170	Brass	No	MR-16	50	Yes	\$ 274.86
MIGL180	Brass	No	MR-16	50	Yes	\$ 274.86
MIGL190	Brass	No	MR-16	50	Yes	\$ 274.86



\*\* Comes with 18" lead.



Unless specified as "Integrated LED"  
Lamps are not included in any Alliance Lighting Fixtures, please refer to page 106-108  
for our selection of Lamps



### Wall Sconces

PART #	MATERIAL/COLOUR	LAMP INCLUDED	LAMP TYPE	MAX. WATT.	LED READY	PRICE
MIWS100	Brass	No	2x Bi-Pin	20	Yes	\$ 173.34
MIWS200	Brass	No	2x Bi-Pin	20	Yes	\$ 273.68
MIWS300	Brass	No	2x MR-16	20	Yes	\$ 319.94



### Hanging Lights

PART #	MATERIAL/COLOUR	LAMP INCLUDED	LAMP TYPE	MAX. WATT.	LED READY	PRICE
MIHL100	Brass	No	MR-16	50	Yes	\$ 232.76
MIHL200	Brass	No	Bi-Pin	20	Yes	\$ 237.87



### Underwater Light

PART #	MATERIAL/COLOUR	LAMP INCLUDED	LAMP TYPE	MAX. WATT.	LED READY	PRICE
MIUL100-LED5W	Brass	Yes	MR-16	5	Yes	\$ 450.45



### Specialty Light and Accessories

PART #	MATERIAL/COLOUR	LAMP INCLUDED	LAMP TYPE	MAX. WATT.	LED READY	PRICE
MITIKI	Brass	N/A	N/A	N/A	N/A	\$ 388.77
MIALSTEM60	Brass - 60"	No	Bi-Pin	35	Yes	\$ 428.57
MIPERMAPOST	Brass/Heavy Duty PVC	Heavy Duty Ground Stake with Brass Cap and Stabilizer Inserts				\$ 178.66
MITIKIWICK		Pack of 5 replacement wicks				\$ 41.31



### Sales Tools

PART #	DESCRIPTION	PRICE
MIDEMOKIT8	Demo Kit Includes a TF150 Transformer, 6 LED Up lights, 2 LED Area lights with Quick Connectors and Storage Case	\$ 2,281.00

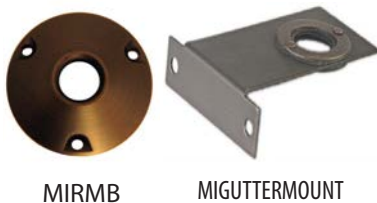

### Accessories

PART #	MATERIAL/COLOUR	DESCRIPTION	PRICE
MIRMB	Brass	Round Mounting Base	\$ 39.51
MIGUTTERMOUNT	Brass	Guttermount Kit	\$ 26.23



### LED Strip Lights

PART #	DESCRIPTION	MAX. WATT.	PRICE
MITAPELED5	5' LED Strip w/10' of wire	3.5W / per foot	\$ 170.01
MITAPELED15	15' LED Strip w/10' of wire	3.5W / per foot	\$ 510.03
MITAPELED30	30' LED Strip w/10' of wire	3.5W / per foot	\$ 1,097.00



*Celebrating...*

20 Years Installed...and still shining strong



- CAST Classic MR-16 Bullet Light (CBL1CB) the fixture that started it all
- Solid Sand-CAST Bronze Shroud, Body AND Stake
- CAST Bronze weathers to a beautiful patina
- Built to Last, enjoyed for many years in the most demanding environments

*Old world craftsmanship...tomorrow's technology®*

**LED MR-16**  
*Easy Identification Lamps*



*Color-Coded  
& Engraved*

- Lamp Color Indicates Wattage of LED
- 20° to 80° Beam Spreads
- Available in 2700K & 3000K
- Beam Angle Engraved on Face of Optic for Accurate Replacement
- 10-75W Halogen Equivalent
- 1-6W Drop-In LED



**CAST Lighting, LLC**

973.423.2303 | [www.cast-lighting.com](http://www.cast-lighting.com)

[info@cast-lighting.com](mailto:info@cast-lighting.com)

**LEARN MORE!**  
**Contact Us Today**



Established 1954

**VANDEN BUSSCHE**  
IRRIGATION

Ask us about our...

**PRODUCT IN-STOCK  
GUARANTEE**



If we are unable to fulfill the outlined products on your order, you will receive \$20 off that Vanden Bussche Irrigation purchase.

**OFFER VALID APRIL 1ST THROUGH SEPTEMBER 30TH**





Old world craftsmanship...tomorrow's technology



### Directional Bullet Lights Incandescent/LED

PART #	MATERIAL/COLOUR	LAMP INCLUDED	LAMP TYPE	MAX. WATT.	LED READY	PRICE
MMCBL1CB	Bronze	No	MR-16	50	Yes	\$ 310.01
MMCBL5CB	Bronze	No	MR-11	20	Yes	\$ 343.77



### Path/Area Lights

PART #	MATERIAL/COLOUR	LAMP INCLUDED	LAMP TYPE	MAX. WATT.	LED READY	PRICE
MMCCH1CB	Bronze	S-8	25W	25	Yes	\$ 485.01
MMCBAL1CB	Bronze	No	MR-16	50	Yes	\$ 564.28

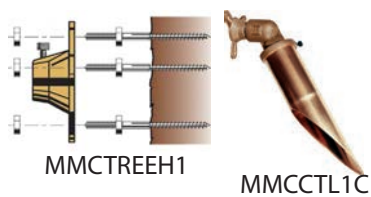

### Tree Light/Accessories

PART #	MATERIAL/COLOUR	LAMP INCLUDED	LAMP TYPE	MAX. WATT.	LED READY	PRICE
MMCCTL1C	Bronze/Copper	No	MR-16	50	Yes	\$ 435.01
MMCTREEH1	Stainless Steel Screws and Nuts (3 Per Set)	N/A	N/A	N/A	N/A	\$ 19.76
MMCTREEH24	Stainless Steel Screws and Nuts (24 Pack, includes driver) - Contractor Pack	N/A	N/A	N/A	N/A	\$ 370.02

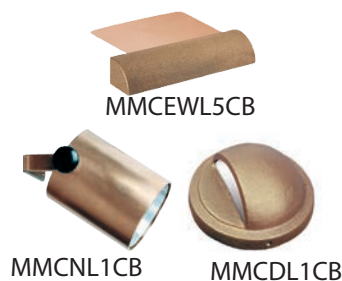

### Wall/Niche/Deck Lights

PART #	MATERIAL/COLOUR	LAMP INCLUDED	LAMP TYPE	MAX. WATT.	LED READY	PRICE
MMCEWL5CB	Bronze	Yes	T-3	20	Yes	\$ 265.02
MMCNL1CB	Bronze/Copper	Yes	T-3	20	Yes	\$ 201.02
MMCDL1CB	Bronze	Yes	T-5	20	Yes	\$ 201.02



# Perfect every time

Problem-solving products that make it easy  
to specify and install with flawless results

# WAC

LANDSCAPE LIGHTING



## ACCENT

Brightness Control Dial

Continuously Adjustable Beam Angles  
10° to 60°



## HARDSCAPE

Brightness Control Dial

Adjust from Warm White (2700K) to  
Pure White (3000K)



## MINI WALL WASH

Brightness Control Dial

Adjust from Warm White (2700K) to  
Pure White (3000K)

[waclandscapelighting.com](http://waclandscapelighting.com)



# Landscape Lighting

## WAC

LANDSCAPE LIGHTING

Dream It. Solve It. Make It.



MY5011BZ

MY5211BZ



MY5111BZ



MY5031BZ



MY5012BZ



MY5121BZ



MY6021BZ



MY6061BK



MY6081BZ



MY6111BK

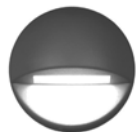

MY3011BZ



MY3021BZ



MY3031BZ

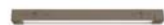

MY7062-27/30BZ

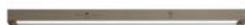

MY7122-27/30BZ

### Spot Lights

PART #	MATERIAL/FINISH	LAMP INCLUDED	LUMENS	WATTAGE	BEAM SPREAD	PRICE
MY5111BZ	Bronze- Mini	Integrated	45 - 365	1W - 7W	10° - 50°	\$ 349.50
MY5111BK	Black- Mini	Integrated	45 - 365	1W - 7W	10° - 50°	\$ 349.50
MY5011BZ	Bronze- Accent	Integrated	190 - 1,045	2W - 16W	10° - 60°	\$ 460.00
MY5011BK	Black- Accent	Integrated	190 - 1,045	2W - 16W	10° - 60°	\$ 460.00
MY5211-27BZ	Bronze- Grand	Integrated	740 - 2000	15W - 35W	15° - 60°	\$ 524.00
MY5211-27BK	Black- Grand	Integrated	740 - 2000	15W - 35W	15° - 60°	\$524.00

### Well Lights

PART #	MATERIAL/FINISH	LAMP INCLUDED	LUMENS	WATTAGE	BEAM SPREAD	PRICE
MY5031BZ	Aluminum Bronze	Integrated	70 - 505	2W - 12W	15° - 60°	\$ 560.00
MY5030BZ	Bronze - Grate for 5031	N/A	N/A	N/A	N/A	\$ 55.00

### Flood Light

PART #	MATERIAL/FINISH	LAMP INCLUDED	LUMENS	WATTAGE	BEAM ANGLE	PRICE
MY5021BZ	Bronze	Integrated	190 - 980	2W - 16W	15° upward (50° x 80°)	\$ 481.00
MY5021-27BK	Black	Integrated	190 - 980	2W - 16W	15° upward (50° x 80°)	\$ 481.00
MY5121-27/30BZ	Bronze	Integrated	80 - 420	1W - 8W	Asymmetrical (70° x 95°)	\$ 393.00
MY5121-27/30BK	Black	Integrated	80 - 420	1w - 8w	Asymmetrical (70° x 95°)	\$ 393.00

### Path Lights

PART #	PRODUCT NAME	MATERIAL/FINISH	LAMP INCLUDED	LUMENS	MAX. WATT.	PRICE
MY6021BZ	Linear LED Path	Bronze	Integrated	95	3W	\$ 450.00
MY6021BK	Linear LED Path	Black	Integrated	95	3W	\$ 450.00
MY6061BZ	Balance Single LED Path	Bronze	Integrated	275	6.5W	\$ 380.00
MY6061BK	Balance Single LED Path	Black	Integrated	275	6.5W	\$ 380.00
MY6081-27BZ	Ledge LED Path	Bronze	Integrated	105	3W	\$ 460.00
MY6081-27BK	Ledge LED Path	Black	Integrated	105	3W	\$ 460.00
MY6111-27BZ	Mini Accent LED Path	Bronze	Integrated	45 - 365	1W - 7W	\$ 728.00

### Deck Lights

PART #	MATERIAL/FINISH	LAMP INCLUDED	LUMENS	MAX. WATT.	PRICE
MY3011BZ	Bronze	Integrated	60	3W	\$ 170.00
MY3021BZ	Bronze	Integrated	60	3W	\$ 172.04
MY3031BZ	Bronze	Integrated	60	3W	\$ 180.00

### Hardscape

PART #	MATERIAL/FINISH	LAMP INCLUDED	LUMENS	SIZE	MAX. WATT.	PRICE
MY7062-27/30BZ	Bronze	Integrated	120	6"	4.5W	\$ 202.78
MY7062-27/30BK	Black	Integrated	120	6"	4.5W	\$ 195.00
MY7122-27/30BZ	Bronze	Integrated	225	12"	7W	\$ 281.23
MY7122-27/30BK	Black	Integrated	225	12"	7W	\$ 271.00



MLRXD02NLBTL

**RX Series Up Lights**

PART #	MATERIAL/ FINISH	LAMP INCLUDED	LAMP TYPE	MAX. WATT.	LED READY	PRICE
MLRXD02NLBTL	Alum/Black	No	MR-16	50	Yes	\$ 123.00



MLAL21NLCOP MLPL17NLBTL  
MLAL21S4BPCPNL

**Area Path Lights**

PART #	MATERIAL/ FINISH	LAMP INCLUDED	LAMP TYPE	MAX. WATT.	LED READY	PRICE
MLAL21NLCOP	Copper (Scout)	No	Bi-Pin	20	Yes	\$ 547.51
MLAL21S4BPCPNL	Copper (Scout)	No	Bi-Pin	20	Yes	\$ 508.24
MLPL17NLBTL	Alum/Black	No	Bi-Pin	20	Yes	\$ 274.55



MLSL37CUNL

**Specialty Lights**

PART #	MATERIAL/ FINISH	LAMP INCLUDED	LAMP TYPE	MAX. WATT.	LED READY	PRICE
MLSL37CUNL	Copper	No	MR-11	20	Yes	\$ 236.61



\*BLACK\*

**Fixture Mounting**

PART #	DESCRIPTION	PRICE
MLFA03	Mount Stake Only	\$ 11.12
MLFA24BLT	1/2" Threaded Universal Round Mount - Black	\$ 31.24



**Source Up Light**

PART #	MATERIAL/ FINISH	LAMP INCLUDED	LAMP TYPE	MAX. WATT.	LED READY	PRICE
MMSBL10	Aged Brass	No	MR-16	50	Yes	\$ 86.00

Established 1954  
**VANDEN BUSSCHE**  
IRRIGATION

**WHEREVER, WHENEVER** with the **VBI Mobile App**  
Order parts • Track order status • Check history





Moon Visions Lighting 12 volt LED lighting kits include 380 alloy cast aluminium Duralune™, 50,000 hour LED lamp life, textured bronze finish. The downlight kits include a tree mount with stainless hardware. Stakes for uplights are sold separately under Fixture Accessories..



## High Power LED Lighting Kits

### BR-30 Up/ Down Kits

PART #	DESCRIPTION	LAMP INCLUDED	LAMP TYPE	WATTAGE	MOUNT INCLUDED	PRICE
MLBR30UKIT	12 volt LED Uplight Kit with 3 1/2" Upshield	Yes	GU20	14	No	\$ 682.37
MLBR30DKIT	12 volt LED Downlight Kit with 8" Downshield	Yes	GU20	14	Yes	\$ 682.37



### BR-40 Up/ Down Kits

PART #	DESCRIPTION	LAMP INCLUDED	LAMP TYPE	WATTAGE	MOUNT INCLUDED	PRICE
MLBR40UKIT	12 volt LED Uplight Kit with 4" Upshield	Yes	GU20	22	No	\$ 786.04
MLBR40DKIT	12 volt LED Downlight Kit with 10" Downshield	Yes	GU20	22	Yes	\$ 806.78



## Accessories

PART #	DESCRIPTION	PRICE
MLSGS	Ground Stake	\$ 47.12
MLGU24	Socket Adapter	\$ 22.62
MLTMBZ	Tree Mount	\$ 49.76



## Online Training Portal



- Irrigation Association Certified
- Water Smart Irrigation Professional Certified
- On-Board new or seasonal employees
- Learn potential new services like Landscape Lighting or Drainage

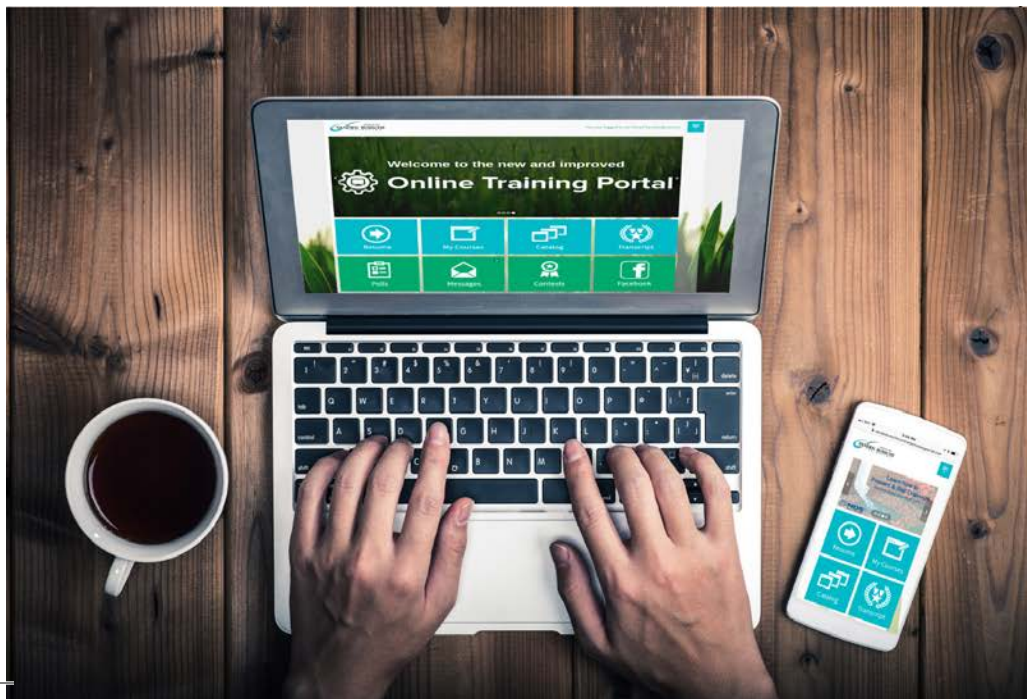

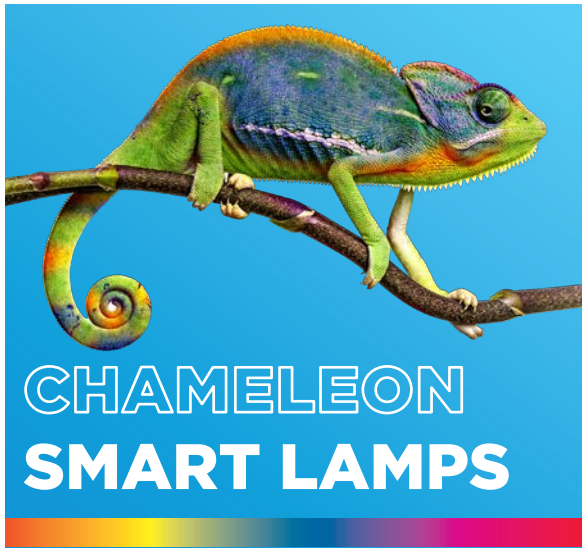

## CHAMELEON SMART LAMPS

- Control lamps via Brilliance Smart individually or in a group
- RGB colors and Kelvin temps from 2200 to 5700
- Set astronomical timers for sunrise/sunset
- Create schedules and timers



**PAR36**



**MR16**



**G4**

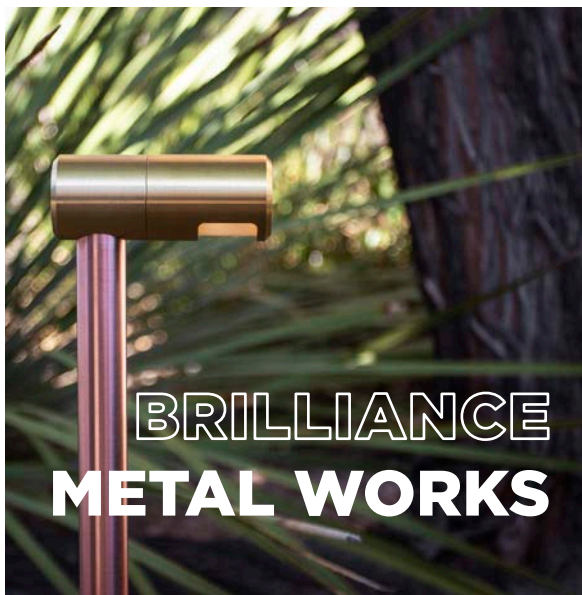

## BRILLIANCE METAL WORKS

- Engineered for performance and built to last
- Highest levels of craftsmanship and tooling
- Majority are American made, with American materials
- Designed with function, durability, and purpose of application in mind



**SEQUOIA**



**DENALI**



**OLYMPIC**



## WHAT YOU CAN EXPECT FROM US

We provide superior customer service to our distributor network, and that extends to contractors and homeowners who use our products.

We seek to offer the finest in-house engineering, craftsmanship, quality control, customer service, technical support, and warranties.

We look for ways to make your job easier and to provide the innovative LED lighting products your lighting designs need.



## LED Lamps



MR-8

### MR-8

PART #	BASE	WATTAGE	LUMENS	COLOUR	SPREAD	VOLTAGE	PRICE
MLMR8WW30	MR-8	1.5	90	Warm White	30	8-25	\$ 46.80



MLMR-11

### MR-11

PART #	BASE	WATTAGE	LUMENS	COLOUR	SPREAD	VOLTAGE	PRICE
MLMR11WW30	MR-11	2	120	Warm White	30	8-25	\$ 52.45
MLMR11WW60	MR-11	2	120	Warm White	60	8-25	\$ 52.45



MLMR-16 ECO



MLMR-16

### MR-16

PART #	BASE	WATTAGE	LUMENS	COLOUR	SPREAD	VOLTAGE	PRICE
MLMR164ECO15	MR-16	4	230	Warm White	15	8-25	\$ 36.88
MLMR164ECO30	MR-16	4	230	Warm White	30	8-25	\$ 36.88
MLMR164ECO60	MR-16	4	230	Warm White	60	8-25	\$ 36.88
MLMR165WW15	MR-16	5	320	Warm White	15	8-25	\$ 68.35
MLMR165WW30	MR-16	5	320	Warm White	30	8-25	\$ 68.35
MLMR165WW60	MR-16	5	320	Warm White	60	8-25	\$ 68.35
MLMR167WW15	MR-16	7	420	Warm White	15	8-25	\$ 80.95
MLMR167WW30	MR-16	7	420	Warm White	30	8-25	\$ 80.95
MLMR167WW60	MR-16	7	420	Warm White	60	8-25	\$ 80.95
MLMR164W300030	MR-16	4	350	Warm White	30	8-25	\$ 63.41
MLMR165W300030	MR-16	5	400	Warm White	30	8-25	\$ 68.35
MLMR165W300060	MR-16	5	400	Warm White	60	8-25	\$ 68.35
MLMR167W300030	MR-16	7	715	Warm White	30	8-25	\$ 80.95
MLMR16CHAMELEON	MR-16	6	328-441	Colour Changing	38	11-18	\$ 84.86



MLMR-16 CHAM



MLAR-11

### AR-11

PART #	BASE	WATTAGE	LUMENS	COLOUR	SPREAD	VOLTAGE	PRICE
MLAR11WW30	AR-11	3	130	Warm White	30	8-18	\$ 52.45



MLBIPINCHAM



MLECOG4



MLT5ECO-WW

### Bi-Pin/Wedge Base

PART #	BASE	WATTAGE	LUMENS	COLOUR	SPREAD	VOLTAGE	PRICE
MLBIPINCOG4WW-2	G4	2	150	Warm White	360	10-14	\$ 20.85
MLBIPINCOG4WW-3	G4	3	240	Warm White	360	10-14	\$ 23.14
MLT5ECO-WW	T5	3	240	Warm White	270	8-14	\$ 23.55
MLG4CHAMELEON		2.5	190-250	Colour Changing	Omni-Directional	8-18	\$ 99.00



MLBIPING4RECWAFFER

### Wafer Bi-Pin

PART #	BASE	WATTAGE	LUMENS	COLOUR	SPREAD	VOLTAGE	PRICE
MLBIPING4RECWAFFER	G4	2	120	Warm White	180	8-18	\$ 31.10

MLBEACONSCBWW



### Single Contact Bayonet

PART #	BASE	WATTAGE	LUMENS	COLOUR	SPREAD	VOLTAGE	PRICE
MLBEACONSCBWW	S.C.B.	2	130	Warm White	30	8-18	\$ 43.50



MLBEACONS8WW

### S8 Wedge Base

PART #	BASE	WATTAGE	LUMENS	COLOUR	SPREAD	VOLTAGE	PRICE
MLBEACONS8WW	S8	2	130	Warm White	n/a	8-18	\$ 43.50

# BRILLIANCE LED®

A HIGHER LIGHT FORM™



MLPAR-36

## LED Lamps

PAR-36

PART #	WATTAGE	LUMENS	KELVIN	PRICE
MLPAR364WW30	4	435	2700K	\$ 150.19
MLPAR367WW30	7	675	2700K	\$ 150.19
MLPAR3611WW30	11	900	2700K	\$ 187.01
MLPAR36CHAMELEON30	9	442-686	220K-5700K	\$ 188.50



Custom make your own LED Strip Lighting

## LED Strip Lighting

LED Strip Lighting / Accessories

PART #	DESCRIPTION	PRICE
MLSLGENIII	Strip LED 2700K, Voltage 8-16, Wattage 1.8w per Metre, 82 ft reel	\$ 2,507.35
MLSL40KIT	½ reel (40 feet) strip lighting kit	\$ 1,625.00
MLSLPFKIT	Strip LED Power Feed Kit	\$ 28.00
MLSLCSKIT	Strip LED Clips and Screws, 50 Clips, 100 Screws	\$ 63.53
MLSLECKIT	Strip LED end Cap with Head Shrink	\$ 3.76
MLSLDCKIT	Strip Led Double Sided Connector Kit	\$ 13.28
MLSLJCKIT	Strip LED Jumper Connector Kit	\$ 42.09
MLSLEXC-G	Extrusion Kit 1 Meter	\$ 49.50
MLLEDSTRIP	Per foot, special order - LED strip lighting	\$ 119.00

MLBRILBLEDS

MLBRIMBLEDS

MLBRILBLEDM

MLBRIMBLEDM



## Light Bars

PART #	DESCRIPTION	PRICE
MLBRILBLEDS	Light Bar Small LED 5-1/4"	\$ 89.66
MLBRIMBLEDS	Light Bar Mounting Brackets Small	\$ 20.27
MLBRILBLEDM	Light Bar Medium LED 9"	\$ 121.13
MLBRIMBLEDM	Light Bar Mounting Brackets Medium	\$ 33.28



MLAQUABEAMWW



MLMINIBEAM

## Specialty

PART #	DESCRIPTION	PRICE
MLAQUABEAMWW	Aquabeam Fixture	\$ 570.01
MLMINIBEAM	Minibeam Fixture - water safe	\$ 93.00



MLDIMMER

## Dimmer Switch

PART #	DESCRIPTION	PRICE
MLDIMMER	Up to 120 WATT, Compatible with all Brilliance LED Lamps - Single Zone	\$ 349.19
MLZONECONTROL	Wifi Zone Control Dimmer	\$ 589.65

## LED Line Voltage Lamps - 120V

PART #	BASE	WATTAGE	LUMENS	KELVIN	PRICE
MLS14WW	S14	3.5	245	2700K	\$ 59.87
MLA19EDGE-C	A19	6.5	500	2700K	\$ 30.97
MLCANLV12C	Candelabra	3.5	275	2700K	\$ 51.43
MLPAR20IOS	PAR20	7	320	2700K	\$ 93.92
MLPAR30IOS	PAR30	12	620	2700K	\$ 120.00



MLS14EDGE-M



MLA19EDGE-C



MLCANLV12C



MLPAR20



MLPAR30



MLBISCAYNE-F



MLBISCAYNE-G

## Subsurface/Well Lights

PART #	DESCRIPTION	PRICE
MLBISCAYNE-F	Flat Top- Black/Composite Finish	\$ 204.03
MLBISCAYNE-G	Grate Top- Black/Composite Finish	\$ 204.03





## Transformers, Timers & Accessories



### Smart Timers



PART #	DESCRIPTION	PRICE
MLCS-ART	Astronomical Timer	\$ 258.00
MLGM2	Astronomical Wifi Timer	\$ 155.00
MLBLEDSOCKET	Astronomical Wifi Timer	\$ 117.81
MLZONECONTROL	Wi-Fi Low Voltage Zone Control	\$ 589.65



Old world craftsmanship...tomorrow's technology

### Cast Transformers/Timers Photo Cell



PART #	MATERIAL/COLOUR	WATTS	VOLTAGE TAPS	COMMONS	PRICE
MMCJT75SSMTTC	Stainless Steel (timer included)	75	12v - 15v	1	\$ 401.41
MMCJ300SSMT	Stainless Steel (timer not included)	300	12v - 15v	1	\$ 771.74
MMCJ600SSMT	Stainless Steel (timer not included)	600	12v - 15v	1	\$ 1,084.02
MMCJ900SSMT	Stainless Steel (timer not included)	900	12v - 15v	1	\$ 1,413.51
MMCTTC	Manual Timer	n/a	n/a	n/a	\$ 60.01
MMCTDTC	Digital Astronomical Timer	n/a	n/a	n/a	\$ 98.50
MMCTPC	Plug in Photocell	n/a	n/a	n/a	\$ 88.25



### FX Transformers/Accessories



PART #	DESCRIPTION	PRICE
PDDX300M	300W Digital facepack - Controlled transformer with astronomical timing and event based programming	\$ 1,232.62
PDEX150M	150W Matte Finish Transformer- No timer	\$ 410.02
PDPXSYNC	Lighting Synchronizer for 24V Irrigation Controller	\$ 116.03



### Alliance Transformers / Timer

PART #	DESCRIPTION	WATTS	PRICE
MIIT150	Bluetooth ready, Program via Phone App	150	\$ 961.05
MIIT300	Bluetooth ready, Program via Phone App	300	\$ 1,091.62
MIXF150	Stainless Steel (timer not included)	150	\$ 608.97
MIXF300	Stainless Steel (timer not included)	300	\$ 742.35
MIXF600	Stainless Steel (timer not included)	600	\$ 1,334.51
MITIMER2	Mechanical Timer	N/A	\$ 64.14
MIITIMER	Bluetooth Timer - Suitable Indoor or Outdoor	N/A	\$ 446.12

# Lighting Installation Material & Accessories



### Standard CSA Landscape Lighting Wire



PART #	DESCRIPTION	WIRE GAUGE	ROLL LENGTH	PRICE
MO102250	10 Gauge Lighting Wire	10	250'	\$ 514.00
MO122250	12 Gauge Lighting Wire	12	250'	\$ 252.60
MO122500	12 Gauge Lighting Wire	12	500'	\$ 505.21



### Silicone Filled Lighting Wire Connectors

PART #	DESCRIPTION	BAG QTY.	PRICE
MBKG	Grey Connector - King Innovation Watertight	20/BAG	\$ 2.31/EACH
MBKGCAN	Can of Grey Connectors - Sold per Can	100/CAN	\$ 163.77
MBKG500	Jug of Grey Connectors - Sold per Jug	500/JUG	\$ 736.46
MBKB	Blue Connector - King Innovation Watertight	10/BAG	\$ 2.80/EACH
MBKBCAN	Can of Blue Connectors - Sold per Can	50/CAN	\$ 133.89
MIALOC	Blue Quick Lock Connector - Alliance Outdoor Lighting	22/CAN	\$ 2.53/EACH



### Ace Connectors

PART #	DESCRIPTION	BOX QTY.	PRICE
MBACE	Medium Connector with Shrink Tubing	50	\$ 9.27



### Tree Ties/Electrical Tape

PART #	DESCRIPTION	BAG QTY.	PRICE
MBTREETIE8	8" Cable Tree Ties with Screw Mount	50/BAG	\$ 5.99
BA1-ETB	Black Electrical Tape	EACH	\$ 1.24
MBTLMOUNT	1/2" Thread Universal Tree Mount	6/BOX	\$ 80.34



### Lighting Tools

PART #	DESCRIPTION	PRICE
MBLTOOL	Lighting Multi Tool	\$ 64.40
MBWS	Standard Wire Stripper	\$ 15.45
MBWS-SA	Self Adjusting Wire Stripper	\$ 29.56
AKPRO40	True RMS Digital Multimeter Pro40	\$ 84.00



### Socket Replacement

PART #	DESCRIPTION	PRICE
MLRP80	12 Volt - Single contact Socket Replacement	\$ 11.68
MLRP55DL1314	12 Volt - MR16 Socket Replacement	\$ 13.24

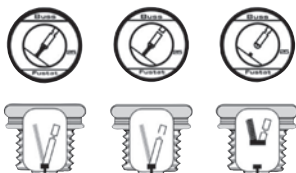

### Transformer Fuses

PART #	DESCRIPTION	PRICE
MFS10	10 Amp Fusestat	\$ 36.00
MFS15	15 Amp Fusestat	\$ 19.00
MFS25	25 AMP Fusestat	\$ 19.00



## THE ROOT TO YOUR SUCCESS

Specializing in professional turf, lawn care, forage and corn.



PART #	DESCRIPTION	QUANTITY	PRICE
MTAGGRESSOR-P	Aggressor PR Mixture Pail	5 kg	\$ 47.00
MTAGGRESSOR	Aggressor PR Mixture Bag	25 kg	\$ 139.00
MTESTATE-P	Estate Lawn Mixture Pail	5 kg	\$ 44.50
MTESTATE	Estate Lawn Mixture Bag	25 kg	\$ 150.00

ASK YOUR TERRITORY MANAGER ABOUT ORDERING THE RIGHT SEED FOR YOUR BUSINESS.

# SEED SPECIES OVERVIEW

Kentucky Bluegrass

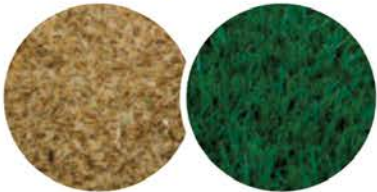

Annual Ryegrass

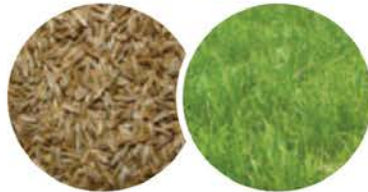

Perennial Ryegrass



White Clover

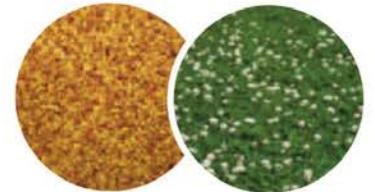

Tall Fescue



Creeping Red Fescue



Chewings Fescue



Bentgrass



SPECIES	DAYS TO ESTABLISH	RHIZOMES SELF REPAIRING	WEAR TOLERANT	DROUGHT TOLERANT	SHADE TOLERANT	COLD TOLERANT	ENDOPHYTES (DISEASE / INSECT RESISTANT)
Perennial Ryegrass	5-10	No	Very Good	Fair	Fair-Good	Fair	High
Kentucky Bluegrass	21-28	Yes	Good	Good	Poor	Very Good	None
Tall Fescue	14-21	Some	Very Good	Excellent	Very Good	Good	High
Chewings Fescue	14-21	No	Good	Good	Very Good	Good	Low
Creeping Red Fescue	14-21	Yes	Fair	Good	Very Good	Good	Medium
Hard Fescue	14-21	No	Fair-Poor	Good	Very Good	Good	Low







# arbourdale™

Proudly partnered with  
**VANDEN BUSSCHE IRRIGATION**  
to provide **EXPERT** pond solutions.



[WWW.ARBOURDALE.COM](http://WWW.ARBOURDALE.COM)





**Arbourdale Pond Care**

PART #	DESCRIPTION	QUANTITY	PRICE (NET)
OB110044	Blast Instant Bacteria	4 pack	\$ 74.93
OB11004	Blast Instant Bacteria	12 pack	\$ 226.88
OB51116	Aquasphere	1 sphere	\$ 129.49
OB52005	Pond Dye - Niagara Blue	5 pack	\$ 95.25
OB52006	Pond Dye - Muskoka Black	5 pack	\$ 95.25
OB6811	Renew	10L pail	\$ 179.60

**\*\* WE RECOMMEND A POND ASSESSMENT BY VANDEN BUSSCHE IRRIGATION STAFF \*\***

## Blast



- Used as a shock treatment
- 1 box treats 1,500,000 gallons of water
- Used with biosphere to compensate for seasonal spikes
- 100% natural and biodegradable

Recommended for hard to treat ponds with high amounts of floating organic matter.



## Aquasphere

- Used as a maintenance product
- Treats 500,000 gallons of water
- Gently toss into pond every 30 days
- 100% natural and biodegradable

Designed to prevent pond issues before they arise, promoting overall pond health.



## Pond Dye - Black

- Used as a maintenance product
- 1 box treats 1.5 acre pond with average depth of 4 feet
- Use until desired colour is achieved
- 100% natural liquid

Pond dye minimizes light penetration resulting in less algae growth and beautiful reflections.



## PhosARREST

- Simply spray over the water surface
- PhosARREST descends through the water column drawing in and binding phosphorus rendering it unavailable to algae
- Without phosphorus algae cannot form
- Apply early in spring to prevent algae formation all year
- Re-application may be required in high-phosphorus conditions

# Aqua Control

www.aquacontrol.com

## Aerators & Fountains

The highest quality aerators & fountains on the market. With over thirty nozzle styles, multiple horsepower Grundfos motors to choose from, custom control packages & optional lights, the Aqua Control aerator & fountain packages are the best available.



EVOLUTION  
SERIES

Aeration Options available,  
call for more information

## EVOLUTION FOUNTAIN IN A BOX

**\$ 2,635.98 net**

- Floating Fountain
  - 1/2 HP, 115V. Single Phase
  - 100' motor cable
  - Two mooring stakes (with rope)
  - Controller
  - Tornado spray pattern
  - Height: 6', Width: 15', GPM 134
- \*\* 175' motor cable available.

### OPTIONAL LIGHTING - \$1,107.00 net

- 100' wire
- 4 High power LED lights
- Warm white lamps standard
- Optional colours available
- \*\* 175' wire available







## Your Paradise Our Passion®

Aquascape is a range of products ideal to give you the contractor a great opportunity to expand your services to your customers.

[www.aquascapeinc.com](http://www.aquascapeinc.com)

## Pond & Pondless® Kits

### Pond Kits



PART #	DESCRIPTION	PRICE
NC99765	Micro Pond Kit 8' x 11' (1000 gal)	\$ 1,499.98
NC53009	Medium 11' x 16' Pond Kit w/AquaSurge PRO 2000-4000	\$ 2,961.99



### Pondless Waterfall Kits

PART #	DESCRIPTION	PRICE
NC83001	Pondless Waterfall Kit	\$ 1,499.98
NC53011	Small Pondless w/6ft Stream & AquaSurge PRO 2000-4000 (GYFM)	\$ 1,666.99
NC49000	Pondless Vault	\$ 428.00
NC49001	Pondless Vault Extension	\$ 120.99
NC77000	Waterfall Spillway (Diffuser)	\$ 220.99



## Filtration

### Skimmer Falls

PART #	DESCRIPTION	PRICE
NC9019	Signature Series Skimmer 6.0	\$ 459.99
NC29349	Signature Series Skimmer 8.0	\$ 624.99
NC9020	Signature Series BioFalls Filter 2500 (2" Bulkhead)	\$ 818.99
NC29319	Signature Series BioFalls Filter 6000 (2" Bulkhead)	\$ 1,199.99



### UltraKlean™

PART #	DESCRIPTION	PRICE
NC95058	UltraKlean 1500 Kit/2000 Pressure Filter/AquaForce 1000	\$ 829.98
NC95059	UltraKlean 2500 Kit/2000 Pressure Filter/AquaForce 1000	\$ 949.98
NC95060	UltraKlean 3500 Kit/2000 Pressure Filter/AquaForce 1000	\$ 1,239.98



### IonGen™

PART #	DESCRIPTION	PRICE
NC95012	IonGen System - 2nd Generation (G2)	\$ 509.98
NC95016	IonGen (G2) Replacement Probe	\$ 159.98



### BioBalls™

PART #	DESCRIPTION	PRICE
NC98464	BioBalls (100 pieces)	\$ 79.98

### AquaBlox®

PART #	DESCRIPTION	PRICE
NC29491	AquaBlox - Small Water Matrix	\$ 59.99
NC29492	AquaBlox - Large Water Matrix	\$ 76.99



## Pumps & Aeration

### AquaSurge®

PART #	DESCRIPTION	PRICE
NC91017	AquaSurge® 2000 Pump	\$469.98
NC91018	AquaSurge® 3000 Pump	\$ 539.98
NC91019	AquaSurge® 4000 Pump	\$ 619.98
NC91020	AquaSurge® 5000 Pump	\$ 689.98
NC45009	AquaSurge® PRO 2000-4000 Pump	\$ 849.99
NC45010	AquaSurge® PRO 4000-8000 Pump	\$ 999.99

### Tsurumi

PART #	DESCRIPTION	PRICE
NC29975	Tsurumi 3PL Pump	\$ 803.99
NC29976	Tsurumi 5PL Pump	\$ 1,058.99
NC29977	Tsurumi 9PL Pump	\$ 1,286.99

### AquaForce®

PART #	DESCRIPTION	PRICE
NC91011	AquaForce® 1000 Solids Handling Pump	\$ 269.98
NC91012	AquaForce® 2700 Solids Handling Pump	\$ 369.98
NC91013	AquaForce® 5200 Solids Handling Pump	\$ 539.98

## LED Lighting

### Pond and Landscape Lights

PART #	DESCRIPTION	PRICE
NC84030	LED Pond & Landscape Spotlight Kit 3-Watt (G2)	\$ 174.98
NC84031	Pond & Landscape Spotlight 1-Watt (G2)	\$ 66.98
NC84033	Pond & Landscape Spotlight 3-Watt (G2)	\$ 147.98
NC84034	Pond & Landscape Spotlight 6-Watt (G2)	\$ 200.98

### Waterfall and Fountain Lights

PART #	DESCRIPTION	PRICE
NC84032	LED Waterfall & Landscape Accent Light 1-Watt (G2)	\$ 66.98
NC84009	LED Fountain Accent Light 1-Watt w/Transformer	\$ 80.98

## Water Treatment

### Dosing System

PART #	DESCRIPTION	PRICE
NC96030	Automatic Dosing System for Ponds	\$ 174.98
NC96032	Automatic Dosing System Water Treatment - Maintain (Pond)	\$ 40.98
NC96033	Automatic Dosing System Water Treatment - Clear (Pond)	\$ 40.98

### Ultra™ Pumps

PART #	DESCRIPTION	PRICE
NC91005	Ultra™ Pump 400 GPH	\$ 113.98
NC91007	Ultra™ Pump 800 GPH	\$ 174.98
NC91009	Ultra™ Pump 1500 GPH	\$ 281.98

### Statuary & Fountain Pumps

PART #	DESCRIPTION	PRICE
NC91024	Statuary and Fountain Pump 90 GPH	\$ 24.98
NC91025	Statuary and Fountain Pump 180 GPH	\$ 37.98
NC91026	Statuary and Fountain Pump 320 GPH	\$ 50.98

### Aerators

PART #	DESCRIPTION	PRICE
NC75000	2-Outlet Pond Aerator	\$ 89.98
NC75001	4-Outlet Pond Aerator	\$ 159.98
NC61000	Pond Aerator PRO 60	\$ 349.98

### Ponds

PART #	DESCRIPTION	PRICE
NC96013	Pond Starter Bacteria - 236ml/8oz	\$ 21.98
NC96015	Pond Starter Bacteria - 946ml/32oz	\$ 53.98
NC98887	Beneficial Bacteria for Ponds - 473ml/16oz	\$ 26.98
NC98899	SAB Stream & Pond Cleaner - 250ml/8.8oz	\$ 26.98

### Transformers and Accessories

PART #	DESCRIPTION	PRICE
NC84039	Photocell w/Timer (4/6/8hrs)	\$ 37.98
NC98375	6-Watts 12 Volt Transformer	\$ 33.98
NC98485	20-Watts 12 Volt Transformer	\$ 66.98
NC98486	60-Watts 12 Volt Transformer	\$ 87.98
NC98489	3-Way Splitter for 12 Volt Lighting	\$ 16.98
NC84022	6-Way Splitter for 12 Volt Lighting	\$ 26.98
NC98998	25' Lighting & IonGen™ Cable Extension w/Quick Connects	\$ 22.98
NC84023	25' Lighting Cable w/5 Quick Connects	\$ 33.98

### Contractor Lighting Packs

PART #	DESCRIPTION	PRICE
NC84045	Contractor Lighting Pack - Pond & Landscape Spot Lighting 1-Watt	\$ 375.98
NC84047	Contractor Lighting Pack - Pond & Landscape Spot Lighting 3-Watt	\$ 844.98

### Sludge & Filter

PART #	DESCRIPTION	PRICE
NC98889	Sludge & filter Cleaner/Liquid - 236ml/8.0oz	\$ 18.98
NC98890	Sludge & filter Cleaner/Liquid - 473ml/16.0oz	\$ 26.98
NC98891	Sludge & filter Cleaner/Liquid - 946ml/32.0oz	\$ 46.98



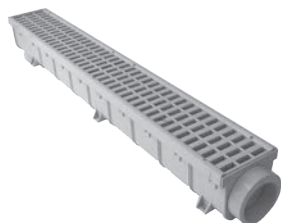

### Channel Drains

PART #	DESCRIPTION	BOX QTY.	PRICE
MRN864CD	1 Meter of 5" Light Traffic Channel with Grate, Outlet and Cap	5	\$ 287.99

see NDS.com for more

## Round Catch Basins and Grates

### SPEE-D® Basins



PART #	DESCRIPTION	BOX QTY.	PRICE
MRN101D	6" Single Outlet with 3" & 4" Locking Outlets	10	\$ 46.82
MRN201D	6" Double Outlet with 3" & 4" Locking Outlets	10	\$ 46.85

### Round Drainage Grates



PART #	DESCRIPTION	COLOUR	BOX QTY.	PRICE
MRN16D	3" Round Drainage Grate	Green	10	\$ 9.29
MRN11D	4" Round Drainage Grate	Black	10	\$ 10.30
MRN13D	4" Round Drainage Grate	Green	10	\$ 10.30
MRN40D	6" Round Drainage Grate	Black	10	\$ 27.49
MRN50D	6" Round Drainage Grate	Green	10	\$ 26.64

### Atrium Drainage Grates



PART #	DESCRIPTION	COLOUR	BOX QTY.	PRICE
MRN70D	3" Atrium Grate	Green	20	\$ 22.69
MRN74D	3" Atrium Grate	Black	20	\$ 22.69
MRN75D	4" Atrium Grate	Green	20	\$ 32.83
MRN78D	4" Atrium Grate	Black	20	\$ 32.83

## Drainage Emitters

### Pop-Up Drainage Emitters



PART #	DESCRIPTION	BOX QTY.	PRICE
MRN421D	4" Pop-Up Emitter with 4" Elbow	20	\$ 71.51
MRN430D	3" & 4" Pop-Up Emitter with Elbow and Universal Adapter	20	\$ 77.51

## Drainage Adapters and Fittings



### Down Spout Drainage Adapters

PART #	DESCRIPTION	BOX QTY.	PRICE
MR9P07	2" x 3" x 3" Centered Down Spout Adapter (First 3" Pipe)	40	\$ 22.81
MR9P08	2" x 3" x 4" Centered Down Spout Adapter (First 4" Pipe)	30	\$ 23.18



### Down Spout Drainage Adapters

PART #	DESCRIPTION	BOX QTY.	PRICE
MR4P01	4" PVC Tee (HUB x HUB)	20	\$ 24.16
MR4P02	4" PVC 90 Deg. Elbow (HUB x HUB)	25	\$ 17.39
MR4P03	4" PVC 45 Deg. Elbow (HUB x HUB)	30	\$ 14.42
MR4P03ST	4" PVC 45 Deg. Street Elbow (HUB x HUB)	60	\$ 23.18
MR4P04	4" PVC 22.5 Deg. Elbow (HUB x HUB)	20	\$ 18.38
MR4P05	4" PVC Coupling (HUB x HUB)	45	\$ 11.59
MR4P06	4" PVC Cap (HUB)	25	\$ 9.98
MR3P07	4"x 3" PVC Reducer Bushing (HUB x SPT)	20	\$ 55.82
MR4P07	4"x 3" PVC Reducer Coupling (HUB x HUB)	20	\$ 21.08
MR4P08	4" PVC 45 Deg. Wye (HUB x HUB x HUB)	20	\$ 31.60
MR4P1X	4" PVC Cross (HUB x HUB x HUB x HUB)	24	\$ 67.38
MR4P11	4" PVC Female Adapter (HUB x FIPT)	24	\$ 23.18
MR41P0	4" PVC 90 Deg. Long Turn Elbow (HUB x HUB)	20	\$ 23.17
MR41POST	4" PVC 90 Deg. Long Turn Street Elbow (HUB x SPT)	20	\$ 28.35
MR41P8	4" PVC Male Plug (MIPT)	50	\$ 13.68
MR9P11	4" PVC Drain Grate (S&D SPT)	25	\$ 16.86



### Square Drainage Grates

PART #	DESCRIPTION	COLOUR	BOX QTY.	PRICE
MRN4D	6" Square Grate with 4" Round Outlet	Black	10	\$ 20.66
MRN640D	6" Square Grate and Adapter With 4" Round Outlet	Black	8	\$ 69.08
MRN637D	6" Square Grate and Adapter With 6" Round Outlet	Black	8	\$ 69.08
MRN771D	7" Square Grate with Round Outlet	Black	10	\$ 33.00
MRN881D	8" Square Grate with Round Outlet	Black	10	\$ 34.04
MRN970D	9" Square Grate with Round Outlet	Green	10	\$ 51.57

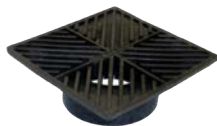

### Drainage Fittings

PART #	DESCRIPTION	COLOUR	BOX QTY.	PRICE
MRN1243D	3" & 4" Universal Locking Outlet	Black	10	\$ 16.51
MRN1266D	6" Universal Adapter	Black	10	\$ 21.67
MRN1206D	Universal Plug	Black	10	\$ 13.40



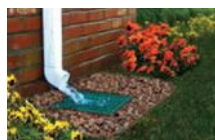

## Square Catch Basins and Grates

Use our NDS inline catch basins and grates to protect property against water damage caused by excess rainwater or irrigation. Use them to collect water from downspouts, planter areas, and landscape areas.

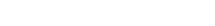
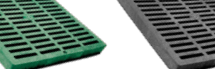
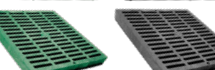
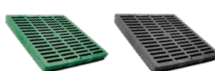

### 9" Catch Basin Series

PART #	DESCRIPTION	COLOUR	BOX QTY.	PRICE
MRN900D	9" Square Catch Basin with 2 Outlets	Black	10	\$ 61.85
MRN9004D	9" Square Catch Basin with 4 Outlets	Black	10	\$ 82.48
MRN916D	9" Square Catch Basin Riser	Black	10	\$ 69.10
MRN930D	9" Square Low Profile Adapter	Black	10	\$ 63.94
MRN980D	9" Square Grate with Round Outlet	Black	10	\$ 80.42
MRN990D	9" Square Grate	Green	10	\$ 80.42

### 12" Catch Basin Series

PART #	DESCRIPTION	COLOUR	BOX QTY.	PRICE
MRN1280D	12" Square Atrium Grate	Green	10	\$ 154.64
MRN1290D	12" Square Atrium Grate	Black	10	\$ 154.63
MRN1211D	12" Square Flat Top Grate	Black	10	\$ 118.55
MRN1212D	12" Square Flat Top Grate	Green	10	\$ 118.53
MRN1200D	12" Square Catch Basin with 2 Openings	Black	5	\$ 108.26
MRN1204D	12" Square Catch Basin with 4 Openings	Black	5	\$ 162.89
MRN1216D	12" x 6" Catch Basin Riser	Black	5	\$ 71.15
MRN1230D	12" Square Low Profile Adapter	Black	5	\$ 84.54

### 18" Catch Basin Series - Special Order, Freight charges may apply

PART #	DESCRIPTION	COLOUR	BOX QTY.	PRICE
MRN1881D	18" Square Atrium Grate	Black	8	\$ 309.30
MRN1811D	18" Square Flat Top Grate	Black	8	\$ 402.07
MRN1812D	18" Square Flat Top Grate	Green	8	\$ 402.06
MRN1882D	18" Square Catch Basin with 2 Openings	Black	4	\$ 589.64
MRN1884D	18" Square Catch Basin with 4 Openings	Black	4	\$ 639.18
MRN1816D	18" x 8" Catch Basin Riser	Black	4	\$ 299.00
MRN1830D	18" Square Low Profile Adapter	Black	4	\$ 225.55
MRN1888D	8" Universal Outlet Adapter	Black	4	\$ 45.38

### 24" Catch Basin Series - Special Order, Freight charges may apply

PART #	DESCRIPTION	COLOUR	BOX QTY.	PRICE
MRN2411D	24" Square Grate	Black	1	\$ 1,056.72
MRN2412D	24" Square Grate	Green	1	\$ 1,056.72
MRN2415D	24" Square Galvanized Steel Grate	Steel	1	\$ 2,474.25
MRN2400D	24" Square Catch Basin with 2 Openings	Black	1	\$ 1,080.04
MRN2404D	24" Square Catch Basin with 4 Openings	Black	1	\$ 1,288.68
MRN2410D	10" & 12" Universal Outlet Adapter	Black	1	\$ 116.78



## ADS Drainage Systems



### Drainage Pipe

PART #	SINGLE WALL CORRUGATED PIPE	PRICE
MUSWS4100	4" x 100' Solid Corrugated Pipe	\$ 179.00
MUSWS4250	4" x 250' Solid Corrugated Pipe	\$ 447.50
MUSWP4100	4" x 100' Perforated Corrugated Pipe	\$ 179.00
MUSWP4250	4" x 250' Perforated Corrugated Pipe	\$ 447.50
MUSWPW4100	4" x 100' Perforated with Filter Corrugated Pipe	\$ 223.00
MUSWPW4250	4" x 250' Perforated with Filter Corrugated Pipe	\$ 557.50
MUSWS6100	6" x 100' Solid Corrugated Pipe	Special Order
MUSWP6100	6" x 100' Perforated Corrugated Pipe	Special Order
MUSWPW6100	6" x 100' Perforated with Filter Corrugated Pipe	Special Order

PART #	FITTINGS	PRICE
MU0421AA	4" Tee	\$ 23.27
MU0661ST	6" Tee	\$ 59.60
MU0417AA	4" Coupling	\$ 6.76
MU0616AA	6" Coupling	\$ 16.15
MU0422AA	4" Y Connection	\$ 23.49
MU0432AA	4" End Cap	\$ 9.29
MU0632AA	6" End Cap	\$ 17.45
MU0490AA	4" Elbow 90°	\$ 18.42

### Low Profile Pipe

AdvanEDGE PIPE	PRICE
12" x 100' Corrugated Low Profile Pipe	Special Order
12" x 500' Corrugated Low Profile Pipe	Special Order
18" x 100' Corrugated Low Profile Pipe	Special Order
18" x 500' Corrugated Low Profile Pipe	Special Order

### Heavy Wall Pipe

HEAVY WALL PIPE & FITTINGS	PRICE
Single Wall 4" Through 24" Pipe	Special Order
Dual Wall 4" Through 24" Pipe	Special Order
4" Through 24" Fittings	Special Order

\*Contact Your Territory Manager For Pricing\*  
All ADS Products Subject To Delivery Charge

### Rain Bird Drainage Systems

#### Rain Bird Drainage Fittings/Pipe

PART #	FITTING/PIPE	PRICE
AXDPUV4EHUB	Pop-Up Valve w/4" Elbow and Hub	\$ 89.67
AXDFLXSOLID8	Flexible Drain Pipe Solid 8'	\$ 31.23
AXDFLXSOLID12	Flexible Drain Pipe Solid 12'	\$ 48.90
AXDFLXPERF8	Flexible Drain Pipe Perf 8'	\$ 31.23
AXDFLXPERF12	Flexible Drain Pipe Perf 12'	\$ 48.90
AXDFLXPERF25	Flexible Drain Pipe Perf 25'	\$ 87.39
AXDFLXSOCK25	Flexible Drain Pipe Sock 25'	\$ 149.79
AXDFLXSPOU3X4	Flex Spout 3" x 4"	\$ 10.41
AXDFLXCOUPL	Flexible Drain Pipe Coupler	\$ 6.78
AXDFLXCONNECT	Flexible Drain Pipe Connector	\$ 12.49
AXDFLXTYCON	Flexible Drainage T/Y Connector	\$ 35.37





# Hand Tools and Accessories



### Trenching Shovel

PART #	DESCRIPTION	NET PRICE
MA21373	3" Blue Handled Trenching Shovel	\$ 59.03
MA21374	4" Orange Handled Trenching Shovel	\$ 59.01
MA21375	5" Red Handled Trenching Shovel	\$ 57.50



### #2 Round Point Shovel

PART #	DESCRIPTION	NET PRICE
MA24182	#2 Round Point Shovel Red D-Grip Handle	\$ 36.50



### Square Mouth Garden Spade

PART #	DESCRIPTION	NET PRICE
MA49453	Square Point Handled Garden Spade	\$ 43.50
MA24382	Square Point Red D-Type Handled Garden Spade	\$ 47.83



### Rakes

PART #	DESCRIPTION	NET PRICE
MA14116	36" Landscape Rake	\$ 110.00
MA42604	18" Garden Rake	\$ 56.65
MALF20	24" Leaf Rake	\$ 12.00



### Lighting Wire Tool

PART #	DESCRIPTION	NET PRICE
MA49045	Landscape Lighting Wire Trencher	\$ 171.00



### Brooms

PART #	DESCRIPTION	NET PRICE
MA82614	Medium Bristle Broom	\$ 80.80
MA82602	Dual Bristle Broom	\$ 79.75



### Tampers

PART #	DESCRIPTION	NET PRICE
MAT410	4" x 10" Dirt Tamper	\$ 78.00
MAT88	8" x 8" Dirt Tamper	\$ 113.39

The warranty on Kenyon and Structron shovels, rakes, tampers, picks and sledge hammers is a "limited Lifetime" Warranty. Tools or accessories which are abused or worn out from normal use are excluded from this warranty. Vanden Bussche Irrigation and Equipment Limited reserves the right to deny a warranty claim for Kenyon or Structron items that have failed for reasons other than defects in materials or workmanship.



**Round Point Shovel**

PART #	DESCRIPTION	NET PRICE
MAS700	Round Point Shovel	\$ 66.37
MASVLR40	Round Point Shovel - Seymour	\$ 33.74



**Structron Trenchers**

PART #	DESCRIPTION	NET PRICE
MAS702	5" Clean-out Style Trencher	\$ 66.37
MAS703	4" Clean-out Style Trencher	\$ 66.37



**Drain Spade**

PART #	DESCRIPTION	NET PRICE
MAS704	5" Drain Spade	\$ 69.49
MA24574	14" Drain Spade - Seymour	\$ 44.72



**Structron Square Mouth Spade**

PART #	DESCRIPTION	NET PRICE
MAS705	Square Point Long Handled Garden Spade	\$ 66.37
MAS705D	Square Point D-Grip Handled Garden Spade	\$ 66.37



**Sledge Hammer**

PART #	DESCRIPTION	NET PRICE
MA41518	10lb Sledge Hammer	\$ 50.95



**Pick**

PART #	DESCRIPTION	NET PRICE
MAPM5H	Pick Head 5lb	\$ 23.50
MA63007	Fibreglass Pick Handle	\$ 54.50



**Measuring Wheel**

PART #	DESCRIPTION	NET PRICE
MAMW19	Measuring Wheel (Per Foot)	\$ 256.23



# Sole Saver

**BEFORE**



**AFTER**



**DIG IT!**



## Helps with:

- ✓ Structure
- ✓ Reduces foot soreness
- ✓ Minimizes looseness in boots
- ✓ Minimal effort with maximum results
- ✓ Minimizes wear and tear

Find it at your local branch counters!

in



f



*USE  
THE  
RIGHT  
TOOL*

*GET THE BEST VALUE*





## Irrigation Tools and Accessories



### Sole Saver

PART #	DESCRIPTION	NET PRICE
MBSOLESAVER	Boot Protector, Digging Tool - Up to Size 11	\$ 69.00
MBSOLESAVER-L	Boot Protector, Digging Tool - Size 11-15	\$ 69.00



### Pipe Cutters

PART #	DESCRIPTION	NET PRICE
MB010-1000	1" Poly Cutter with Stainless Steel Blade	\$ 16.54
MB010-2000	1 1/4" Poly Cutter with Stainless Steel Blade	\$ 18.58
MB010-3000	2" Poly Cutter with Stainless Steel Blade	\$ 20.48
MB010-1025	Replacement Blade for 1" Poly Cutter	\$ 6.31
MB010-2150	Replacement Blade for 1 1/4" Poly Cutter	\$ 6.90
MB010-3315	Replacement Blade for 2" Poly Cutter	\$ 7.83



### Nipple Extractor

PART #	DESCRIPTION	NET PRICE
MBNE005	1/2" and 3/4" Nipple Extractor	\$ 6.74
OR26073	1/2" Nipple Extractor	\$ 6.44
OR26074	3/4" Nipple Extractor	\$ 7.89



### Pinch Clamp Tools

PART #	DESCRIPTION	NET PRICE
QG1097	Dawn Standard Pincer	\$ 24.68
QG1800E	Oetiker Standard Pincer - Blue Handle	\$ 47.00
QG2800E	Oetiker Compound Action Pincer - Blue Handle	\$ 85.00



### Hammers and Strippers

PART #	DESCRIPTION	NET PRICE
MBWS	Wire Stripper	\$ 15.45
MBDBH15	Dead Blow Hammer	\$ 18.84



### PVC Saws

PART #	DESCRIPTION	NET PRICE
MAPVCS	PVC Saw Blue	\$ 37.00
MBPVCS9	9" PVC Saw Orange	\$ 22.76
MBS32	Rope Saw 32"	\$ 8.06



### Groove Lock Pliers

PART #	DESCRIPTION	NET PRICE
MBGJP-100	Groove Lock Pliers 10 Inch	\$ 26.94
MBGJP-160	Groove Lock Pliers 16 Inch	\$ 59.28





### Carrying Storage

PART #	DESCRIPTION	NET PRICE
MBTOTE	Tool Tote	\$ 11.76
MBBUCKETPRO	Bucket With Dividers	\$ 45.00
MBAPRONPRO	Bucket Apron	\$ 28.29



### Utility Knives

PART #	DESCRIPTION	NET PRICE
MBTK300	Turf Knife	\$ 14.82
MBSO123	Snap Off Utility Knife	\$ 4.17
MBITool	15 in 1 Irrigation Tool	\$ 63.60



### Pumps

PART #	DESCRIPTION	NET PRICE
OEG12C5	Ultra Max 18"	\$ 44.45
OEG12S-C	Ultra Small Syringe	\$ 42.01
OEG3672-CK5	Ultra Big Gulp	\$ 56.01



### Pipe Grips

PART #	DESCRIPTION	NET PRICE
MBPG24	Mesh Grip Pipe Puller 24" long, up to 1 1/4" Poly	\$ 165.96
MBPG26	Mesh Grip Pipe Puller 26" long, up to 2" Poly	\$ 253.31

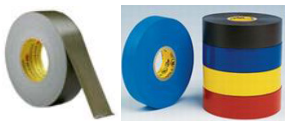

### Tape and Marking Supplies

PART #	DESCRIPTION	NET PRICE
BA3900	Olive Green Duct Tape	\$ 13.75
BA1-ETB	Black Electrical Tape	\$ 1.24
BA1-ETC	Coloured Electrical Tape - Available in blue, red, yellow	\$ 1.32
AXRBF-S	Marking Flags - Sold in bundles of 100	\$ 16.00
ETMP	Marking Paint - Available in blue, red, white, yellow	\$ 14.00



### Pressure Gauges & Accessories

PART #	DESCRIPTION	NET PRICE
DSOFPG160	1/4" Pressure Gauge Oil Filled 160 psi Max	\$ 19.00
OR91130	Pressure Gauge with 3/4" Hose Adapter 200 psi	\$ 10.50
OEA-HCP	1/4" FIPT Pitot Tube	\$ 43.02
PDMPGAUGE	MP Rotator Pressure Gauge	\$ 91.00

**BACKFLOW AND WATER METER PROTECTIVE ENCLOSURE**

- 100% Stainless Steel or marine grade aluminum construction assures long term, rustproof durability and additional strength
- Portable with fork lift openings on the bottom, handles for lifting on sides
- Hinged drop down lid with padlock tab
- Vent hole pattern on lower end section for water drainage
- Side cutouts for 2" piping
- Insulated version; 1" foam insulation, sheeted inside available

**SBBC-40SS**  
**Smooth Touch Backflow Cover**

- 45" Long, 30.5" High, 16" Wide
- All stainless steel 2 piece
- Lockable Lid with hinge
- Weather resistant

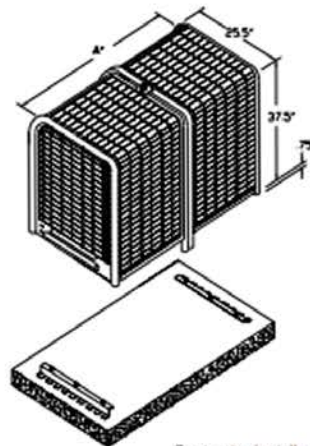
Contractor installed  
concrete pad**SBBC-45ALI**  
**Insulated Low Profile Backflow Enclosure**

- 39.5" Long, 39" High, 25.5" Wide
- Insulated
- Marine grade aluminum
- Lockable Lid with hinge

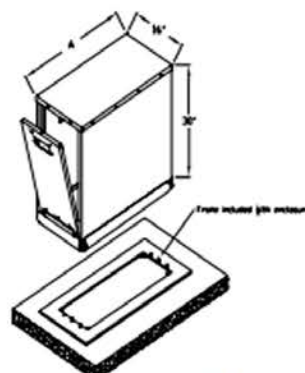
Contractor installed  
concrete pad

Enclosures are available in a variety of sizes and options.  
Reach out to your Territory Manager to find the right solution.



## Friction Loss in Polyethylene SDR-Pressure Rated Tubing Velocity measured in ft / sec., PSI Loss Per 100 Feet of Pipe (PSI/100FT).

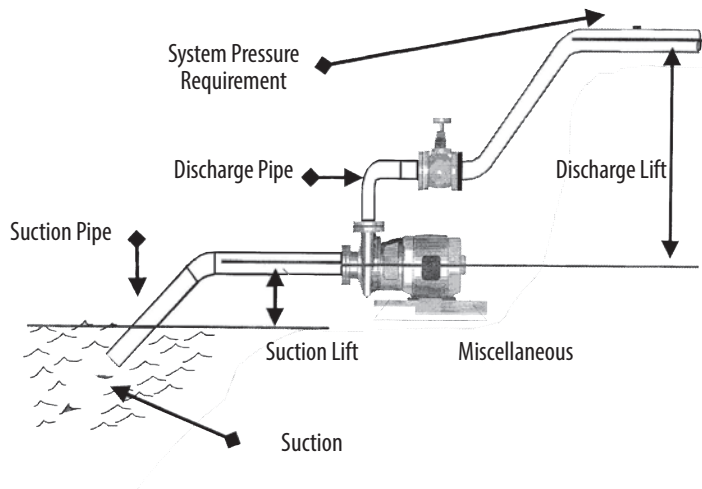
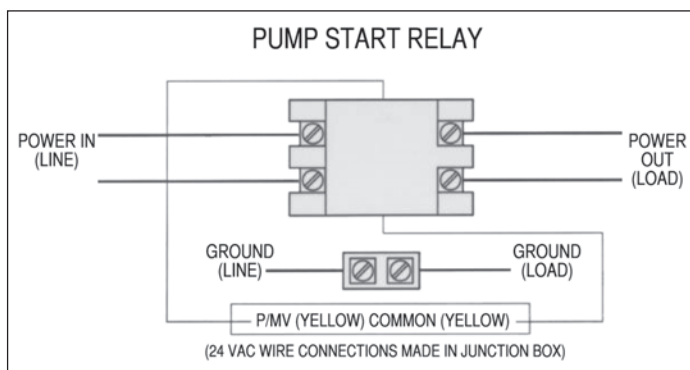

Figure 9-1: Determining Total Dynamic Head (TDH)  
IA Certified Irrigation Contractor Workbook. Chapter 9  
Part No. AXIA-CICW \$49.00



VELOCITY CHART • FLOW IN US GPM (NOT EXCEEDING 5 FT./SECOND)							
PIPE	3/4"	1"	1 1/4"	1 1/2"	2"	2 1/2"	3"
PVC CLASS 200	11	17	28	37	57	85	126
PVC CLASS 160	-	18	29	38	60	90	140
PVC SCH. 40	8	13	23	32	53	80	120
PE (POLY)	8	14	23	32	53	-	-
COPPER TYPE M	8	13	20	28	50	-	-

POLYETHYLENE (PE) • SDR-PRESSURE RATED TUBING (2306,3206) SDR 7, 9, 11.5, 15 C=140 • PSI LOSS PER 100 FEET OF TUBE (PSI/100 FEET) • SIZES 3/4" THROUGH 2"											
"	3/4"		1"		1 1/4"		1 1/2"		2"		
GPM	Vel.	Loss	Vel.	Loss	Vel.	Loss	Vel.	Loss	Vel.	Loss	
1	0.6	0.1									
2	1.2	0.5	0.7	0.1							
3	1.8	1.0	1.1	0.3	0.6	0.1					
4	2.4	1.6	1.5	0.5	0.9	0.1	0.6	0.1			
5	3.0	2.4	1.9	0.8	1.1	0.2	0.8	0.1			
6	3.6	3.4	2.2	1.1	1.3	0.3	0.9	0.1			
7	4.2	4.6	2.6	1.4	1.5	0.4	1.1	0.2	0.7	0.1	
8	4.8	5.8	3.0	1.8	1.7	0.5	1.3	0.2	0.8	0.1	
9	5.4	7.3	3.3	1.9	1.9	0.6	1.4	0.3	0.9	0.1	
10	6.0	8.8	3.7	2.7	2.1	0.7	1.6	0.3	1.0	0.1	
12	7.2	12.4	4.4	3.8	2.6	1.0	1.9	0.5	1.1	0.1	
14	8.4	16.5	5.2	5.1	3.0	1.3	2.2	0.6	1.3	0.2	
16	9.6	21.1	5.9	6.5	3.4	1.7	2.5	0.8	1.5	0.2	
18	10.8	26.2	6.7	8.1	3.9	2.1	2.8	1.0	1.7	0.3	
20			7.4	9.8	4.3	2.6	3.1	1.2	1.9	0.4	
22			8.2	11.7	4.7	3.1	3.5	1.5	2.1	0.4	
24			8.9	13.8	5.1	3.6	3.7	1.7	2.3	0.5	
26			9.6	16.0	5.6	4.2	4.1	2.0	2.5	0.6	
28			10.4	18.4	6.0	4.8	4.4	2.3	2.7	0.7	
30					6.4	5.5	4.7	2.6	2.9	0.8	
35					7.5	7.3	5.5	3.5	3.3	1.0	
40					8.6	9.4	6.3	4.4	3.8	1.3	
45					9.6	11.6	7.1	5.5	4.3	1.6	
50					10.7	14.1	7.9	6.7	4.8	2.0	
55							8.7	8.0	5.3	2.4	
60							9.4	9.4	5.7	2.8	
65							10.2	10.9	6.2	3.2	
70									6.7	3.7	
75									7.2	4.2	
80									7.6	4.7	
85									8.1	5.3	
90									8.6	5.9	
95									9.1	6.5	
100									9.5	7.2	

Note: Shaded areas of chart indicate velocities over 5' per second. Use caution to prevent water hammer.

## Friction Loss in Class 160 (SDR 26) PVC Pipe

### Velocity measured in ft / sec., PSI Loss Per 100 Feet of Pipe (PSI/100FT).

GPM	1 1/4"		1 1/2"		2"		2 1/2"		3"		4"		6"		8"		10"		GPM
	Vel.	Loss	Vel.	Loss	Vel.	Loss	Vel.	Loss	Vel.	Loss	Vel.	Loss	Vel.	Loss	Vel.	Loss	Vel.	Loss	
5	0.9	0.1	0.9	0.1															5
10	1.7	0.4	1.3	0.2	0.9	0.1													10
15	2.6	0.8	2.0	0.4	1.3	0.1	0.9	0.1											15
20	3.5	1.4	2.7	0.7	1.7	0.2	1.2	0.1											20
25	4.4	2.1	3.3	1.1	2.1	0.4	1.5	0.1	1.0	0.1									25
30	5.2	2.9	4.0	1.5	2.6	0.5	1.7	0.2	1.2	0.1									30
35	6.1	3.9	4.6	2.0	3.0	0.7	2.0	0.3	1.4	0.1									35
40	7.0	5.0	5.3	2.6	3.4	0.9	2.3	0.3	1.6	0.1									40
45	7.8	6.2	5.9	3.2	3.8	1.1	2.6	0.4	1.8	0.2	1.1	0.1							45
50	8.7	7.5	6.6	3.9	4.2	1.3	2.9	0.5	2.0	0.2	1.2	0.1							50
55	9.6	8.9	7.3	4.6	4.7	1.6	3.1	0.6	2.2	0.2	1.3	0.1							55
60	10.4	10.5	8.0	5.4	5.1	1.8	3.5	0.7	2.4	0.3	1.4	0.1							60
65			8.6	6.3	5.5	2.1	3.8	0.8	2.5	0.3	1.5	0.1							65
70			9.3	7.2	5.9	2.4	4.1	1.0	2.7	0.4	1.7	0.1							70
75			10.0	8.2	6.4	2.8	4.3	1.1	2.9	0.4	1.8	0.1							75
80					6.8	3.1	4.6	1.2	3.1	0.5	1.9	0.1							80
85					7.2	3.5	4.9	1.4	3.3	0.5	2.0	0.2							85
90					7.6	3.9	5.2	1.5	3.5	0.6	2.1	0.2							90
95					8.1	4.3	5.5	1.7	3.7	0.7	2.3	0.2							95
100					8.5	4.7	5.8	1.9	3.9	0.7	2.4	0.2							100
110					9.3	5.6	6.4	2.2	4.3	0.9	2.6	0.3							110
120					10.3	6.6	7.0	2.6	4.7	1.0	2.8	0.3							120
130							7.5	3.0	5.1	1.2	3.1	0.3							130
140							8.1	3.5	5.5	1.3	3.3	0.4							140
150							8.7	3.9	5.9	1.5	3.6	0.5							150
160							9.3	4.4	6.3	1.7	3.8	0.5							160
170							9.8	5.0	6.7	1.9	4.0	0.6	1.9	0.1					170
180							10.4	5.5	7.0	2.1	4.3	0.6	2.0	0.1					180
190									7.4	2.4	4.5	0.7	2.1	0.1					190
200									7.8	2.6	4.7	0.8	2.2	0.1					200
225									8.8	3.2	5.3	1.0	2.5	0.1					225
250									9.8	3.9	5.9	1.2	2.7	0.2					250
275									10.8	4.7	6.5	1.4	3.0	0.2	1.8	0.1			275
300											7.1	1.6	3.3	0.3	1.9	0.1			300
325											7.7	1.9	3.6	0.3	2.1	0.1			325
350											8.3	2.1	3.8	0.3	2.3	0.1			350
375											8.9	2.4	4.1	0.4	2.4	0.1			375
400											9.5	2.8	4.4	0.4	2.6	0.1			400
450											10.6	3.4	4.9	0.5	2.9	0.1	1.9	0.1	450
500													5.5	0.6	3.2	0.2	2.1	0.1	500
600													6.6	0.9	3.9	0.3	2.5	0.1	600
700													7.6	1.18	4.5	0.3	2.9	0.1	700
800													8.7	1.5	5.2	0.4	3.3	0.1	800
900													9.8	1.9	5.8	0.5	3.7	0.2	900
1000													10.9	2.3	6.4	0.6	4.1	0.2	1000
1250															8.1	1.0	5.2	0.3	1250
1500															9.7	1.3	6.2	0.5	1500

Note: Shaded areas of chart indicate velocities over 5' per second. Use caution to prevent water hammer.



## VOLUME

1 U.S. Gallon.....	231 cu/in.
.....	3.785 litres
1 Imperial Gallon.....	1.2 U.S. gal.
1 Cubic Foot .....	7.48 U.S. gal.
.....	0.0283 cu. metre
1 Litre .....	0.2642 U.S. gal.
1 Cubic Meter.....	35.314 cu.ft.
.....	264.2 U.S. gal.
1 Acre inch.....	3,630 cu. ft.
.....	27,100 U.S. gal.

## LENGTH

1 Inch .....	2.54 cm
1 Metre.....	3.28 feet
.....	39.37 in.

## WEIGHT

1 U.S. Gallon of Water .....	8.33 lb.
1 Cu. Ft. of Water .....	62.35 lb.
1 Kilogram or Litre .....	2.20 lb.

## HORSEPOWER

1 HP.....	0.746 kilowatts
.....	746 watts
.....	33,000 ft. lbs. per minute
.....	550 ft. lbs. per second

## ELECTRIC POWER

AC = Alternating current power  
 DC = Direct Current  
 E = Volts = Electrical pressure  
 (similar to head)  
 I = Ampere = Electrical power  
 (similar to rate off flow)  
 W = Watts = Electrical power  
 (similar to head capacity)  
 KW = Kilowatts = 1000 watts  
 Apparent Power = Volts X Amperes = Watts

## HEAD

1 pound per Sq. Inch (PSI)	.....	2.31 ft. head of water
1 Foot of Water.....	0.433 lb. psi	
1 Kilogram per Sq. Cm. ....	14.22 lb psi	
1 Atmosphere (at sea level).....	14.7 psi	

## CAPACITY

1 Cubic Foot per Second (2d foot)	.....	449 gpm
1 Acre Inch per Hour.....	454 gpm	
1 Cubic Metre per Minute .....	264.2 gpm	
1 Hectare .....	2.47 acres	

### TO FIND CAPACITY OF A TANK OR CISTERN

$$\left( \text{DIAMETER OF TANK IN FEET SQUARED} \right) \times 0.7854 \times \left( \text{HEIGHT OF TANK IN FEET} \right) \times 0.748 = \text{CAPACITY IN US GALLONS}$$

### QUANTITY OF WATER AVAILABLE FROM A SERVICE LINE • US GPM

LENGTH	SIZE	SIZE OF METER	GPM AVAILABLE
50'	3/4"	5/8"	10
50'	3/4"	3/4"	12
50'	1"	5/8"	14
50'	1"	3/4"	18
50'	1"	1"	22
50'	1 1/4"	1"	30
50'	1 1/2"	1"	35
50'	1 1/2"	1 1/2"	45
50'	2"	1 1/2"	60
50'	2"	2"	75
50'	3"	3"	160

### VELOCITY CHART • FLOW IN US GPM (NOT EXCEEDING 5 FT./SECOND)

PIPE	3/4"	1"	1 1/4"	1 1/2"	2"	2 1/2"	3"
PVC CLASS 200	11	17	28	37	57	85	126
PVC CLASS 160	-	18	29	38	60	90	140
PVC SCH. 40	8	13	23	32	53	80	120
PE (POLY)	8	14	23	32	53	-	-
COPPER TYPE M	8	13	20	28	50	-	-

### WIRE SIZING CHART • 1 VALVE PER STATION

Max. length of wire run (ft.) • run includes control wire from controller to valve and common wire from valve to controller.					
AWG SIZE NO.	DIAMETER	STATIC PRESSURE NOT EXCEEDING			
		75 PSI	85 PSI	100 PSI	120 PSI
18	0.040	2200	2000	1600	1100
16	0.051	3600	3200	2500	1800
14	0.064	5700	5000	4000	3000
12	0.081	9000	8000	6400	4700
10	0.102	14000	12700	10200	74000
8	0.129	22700	20200	16200	11800
MULTIPLIER OF 2 VALVES PER STATION		0.43	0.40	0.41	0.38



Established 1954

# VANDEN BUSSCHE

IRRIGATION



## DELHI HEAD OFFICE

P.O. Box 304, 2515 Pinegrove Rd., Delhi, ON, N4B 2X1  
 Tel: (519) 582-2380 • Toll Free: 1-800-387-7246 (RAIN)



## BURLINGTON - LANDSCAPE & GOLF

2462 Industrial St. Units 3 & 4, Burlington, ON, L7P 1A5

Tel: (905) 634-7246 (RAIN)



## CONCORD - LANDSCAPE & GOLF

77 Maplecrete Rd, Concord, ON, L4K 1A5

Tel: (905) 660-5464 • Toll Free: 1-866-703-5464



[www.vandenbussche.com](http://www.vandenbussche.com)

[info@vandenbussche.com](mailto:info@vandenbussche.com)

